



CENTUM VP
for **Batch Control**

Pulp & Paper
Food & Beverage

Chemical
Pharmaceutical

Integrated Production Control System

CENTUM VP for **Batch Control**

Bulletin 33M05L10-40E

www.yokogawa.com/centumvp

vigilantplant.[®]
The clear path to operational excellence

YOKOGAWA 

A Wealth of solutions for Batch Process **ALL in ONE**

The CENTUM VP Distributed Control System provides scalable and powerful solutions for continuous, batch and hybrid applications. VP Batch is the ISA-88 (IEC-61512) batch control package for CENTUM VP, which provides recipe management, process management and unit supervision functionality. The CENTUM VP is unique in performing unit supervision functions in completely redundant real-time controllers that are inherited from the field proven CENTUM CS 3000 systems offering an availability of 99.99999 percent, or “seven-9s.” VP Batch recipe management, scheduling and production information management functions can also be easily integrated into your Manufacturing Execution Systems (MES), supply chain and enterprise management systems to meet the increasing demands for leaner and more agile manufacturing operations.

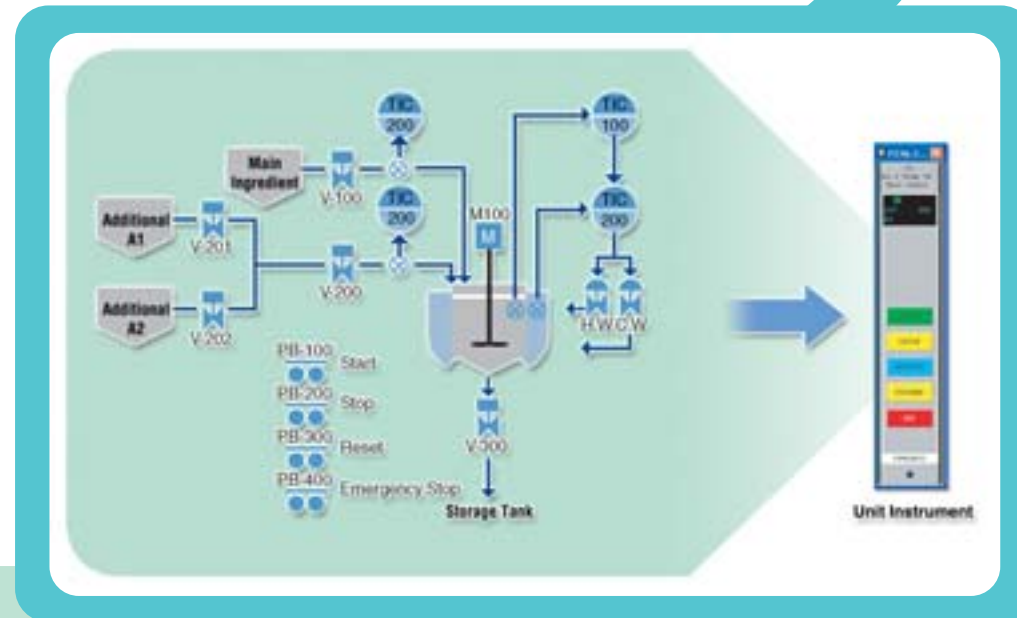
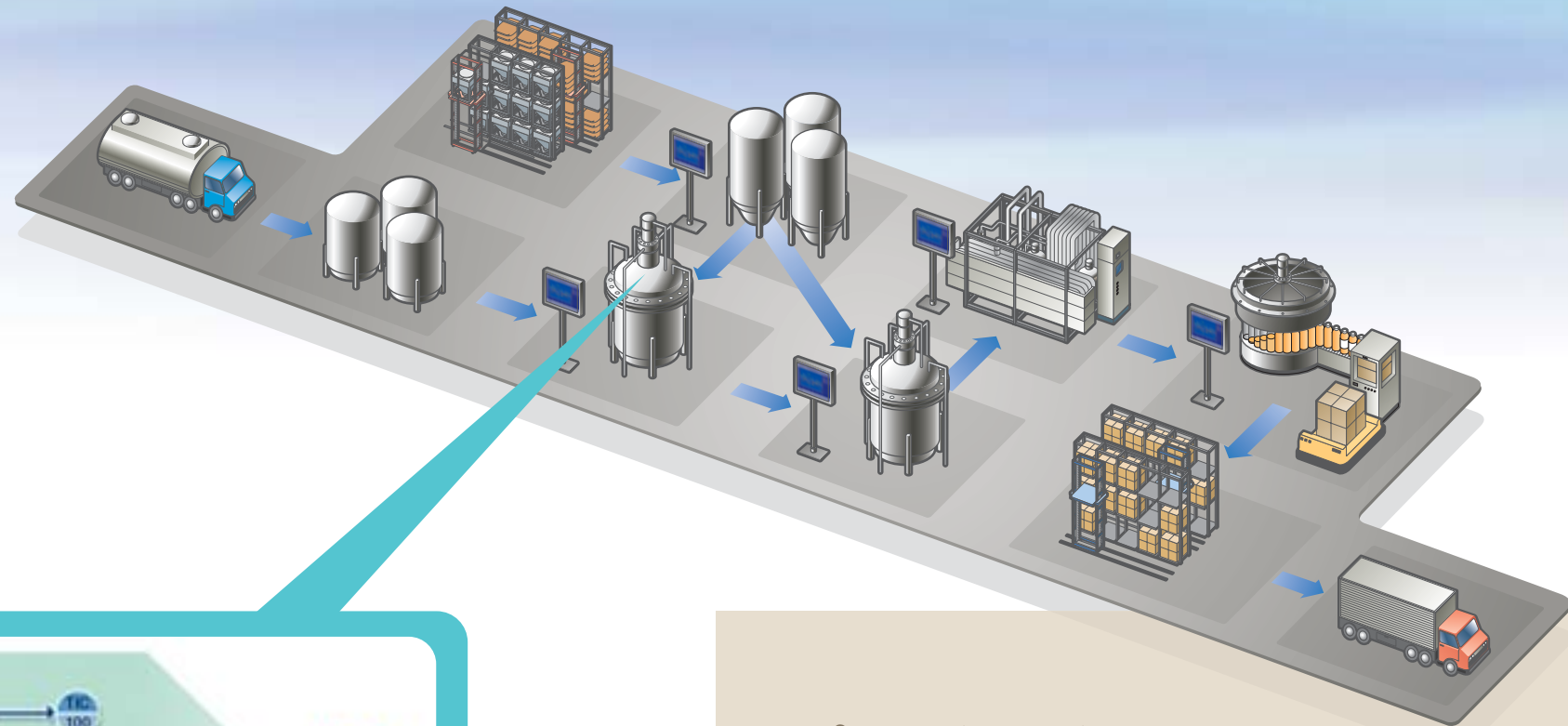

C o n t e n t s

04 Scalable and Reliable System Architecture

- Scalable Solution from Unit Control to Site Automation
- Highly Reliable Controllers
- Effortless Integration with Other Systems

06 Modular Engineering

- Hierarchical and Modular Configuration
- Object Oriented Phase Logic Structure
- Easy Testing Environment

08 Powerful and Advanced Unit Supervision

- User Configurable Unit State Matrices
- Plug-in Exception Handling and Monitoring Routines
- Support for Audit Trails, Electronic Records and Signatures

10 Easy Operation

- Intuitive View of Batch and Equipment Control
- Integration of Automated Control and Manual Operations
- 21 CFR Part 11 Support

12 Electronic Batch Records

- Flexible Batch Reporting
- Complete Batch Production Information Management System

14 Intelligent Solution Suite

- Recipe Management
- Production Planning and Scheduling
- Batch Production Information Management

VP Batch offers flexible and scalable batch management software for centralized recipe and process management combined with distributed unit supervision. VP Batch is field proven, having been used to automate a wide range of batch processes from simple, single product/single unit processes to flexible and complex multi-product/multi-path processes, with ease of use, outstanding reliability, and sophisticated functionality. Using VP Batch you can benefit from:

- **Reduced lifecycle engineering costs**
- **Shortened time to market**
- **Improved plant performance**
- **Reduction in unexpected control failures**

Scalable and Reliable System Architecture

Batch processes often require complex, modular and advanced resource management regardless of the scale. This is, especially true when multiple products require flexible combinations of equipment modules, units, lines and trains. CENTUM VP provides solutions for batch control irrespective of process scale.

? Your Challenge

Seamlessly handle all processes, ranging from 100 I/O points to over 30,000 I/O points, with a single system.

! Yokogawa's Solution

The CENTUM VP controls plants of any scale with a single architecture.

The smallest CENTUM VP system consists of a single PC, with operation, monitoring and engineering functions, integrated with a compact field control station. The system can be expanded online as your plant grows.

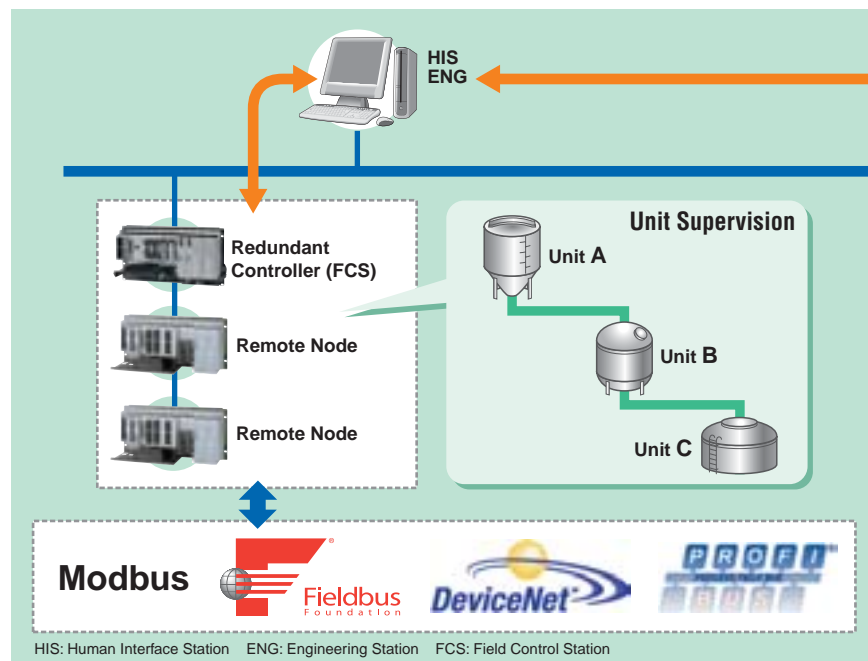

? Your Challenge

Minimize costly downtime and lost revenue due to control system downtime.

! Yokogawa's Solution

Unit procedures are executed in highly reliable controllers.

In VP Batch, the unit supervision function, which is the ISA-88 activity requiring the highest reliability, runs on ultra-reliable controllers. This means all unit procedures, operations, and phases are loaded and executed in controllers which can be fully redundant. It is the only system which completely executes unit recipes, including unit procedures and unit formula, in the controllers, thus leading to increased system reliability. This allows a control recipe to be able to run to completion without regard to the state of other PCs, servers or any other hardware. Furthermore, a completely integrated database is provided to simplify system configuration with automatic backup of configuration data a standard feature.

? Your Challenge

Seamlessly integrate multiple vendors' systems to create a unified batch control system.

! Yokogawa's Solution

CENTUM VP is able to communicate with any OPC (OLE for Process Control) enabled control or information system using OPC interfaces that are integral components of the system.

Connection with PLCs, skid based controls, laboratory information systems, electrical facilities, machining equipment, automated vehicle systems, and warehouse control systems have been field-proven in many projects. CENTUM VP's integral OPC interfaces enable effortless connectivity to hundreds of different systems via OPC. The integrated functions permit data from OPC enabled systems to be displayed and used in CENTUM VP the same as field I/O signals.

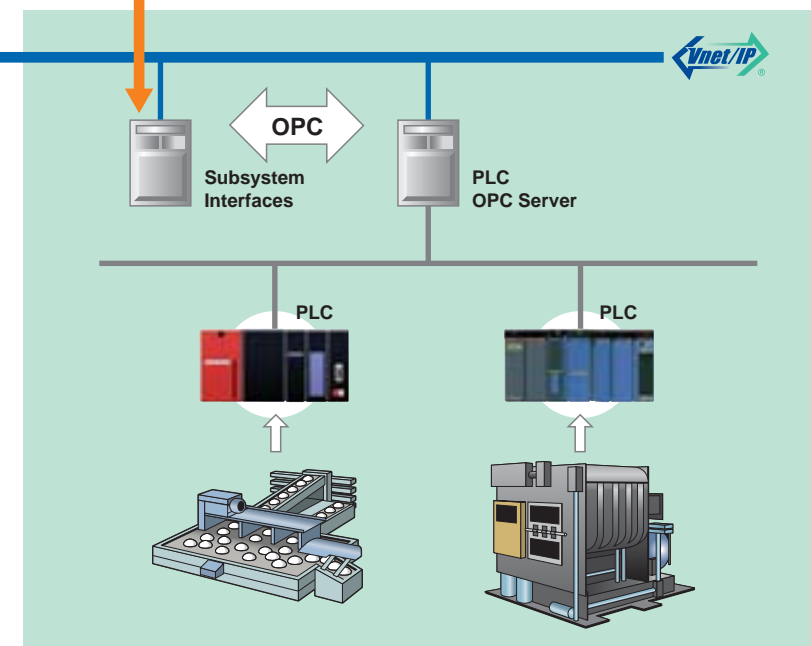

Modular Engineering

Yokogawa's wealth of batch control experience is evident in the VP Batch package, which is based on the ISA-88 batch control standard.

This modular, hierarchical package supports reusable components and libraries for easy engineering. Configurations can also be tested by simulating field control stations in a PC.

? Your Challenge

Reduce the engineering cost of controlling frequently changing processes and products.

! Yokogawa's Solution

Hierarchically structured logic allows intuitive engineering.

Hierarchically structured unit instruments and modular Sequential Function Charts (SFC) offer concise and intuitive engineering making control strategies easy to modify and less costly to maintain. The single integrated engineering tool and database further reduces engineering costs by making the initial development and maintenance of control strategies less costly.

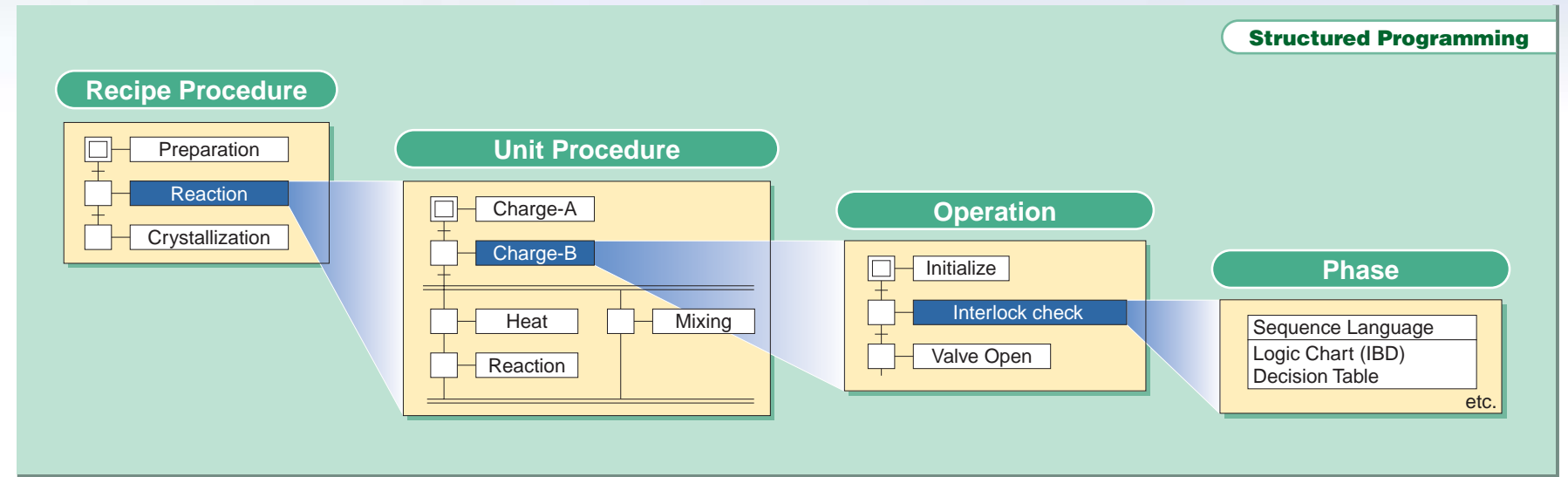

? Your Challenge

Use common batch control sequences among many similar reactors.

! Yokogawa's Solution

You only have to configure one set of phase logic and graphics for similar equipment.

In VP Batch, a unit instrument is assigned to each batch unit (e.g. reactor, centrifuge, filter dryer etc). As shown in the figure above, a unit instrument comprises hierarchically structured modules using Sequential Function Charts (SFCs).

Operations, phases, and graphics can be written using generic names (aliases), thus making the logic independent of equipment. For example, a generic name such as "Valve 1" can be used to express a tag in logic instead of the actual tag name.

For many batch units, only one set of operations and graphics need to be developed. Multiple reactors can run concurrently without needing equipment specific operations.

? Your Challenge

Configure and test a system anywhere with a laptop PC.

! Yokogawa's Solution

You can test your application using Yokogawa's unique Virtual Test Function add-in without the actual controller or I/O.

For all types of processes, development and testing of control applications can be done without dedicated hardware. With just a PC, you can perform system engineering, testing, and verification anywhere. The Virtual Test Function simulates the complete controller function, including the downloaded unit supervision functions, as well as providing a simple loop back simulation for all I/O, without requiring any engineering. You simply start the Virtual Test Function from a pull-down menu and you can run batches, debug phase logic, verify unit coordination and test exception handling as if you had a process controller connected to the process. This enables accelerated project schedules, reduces development and testing bottlenecks on projects and contributes to the lower TCO (Total Cost of Ownership) you will experience with CENTUM VP controlling your batch processes.

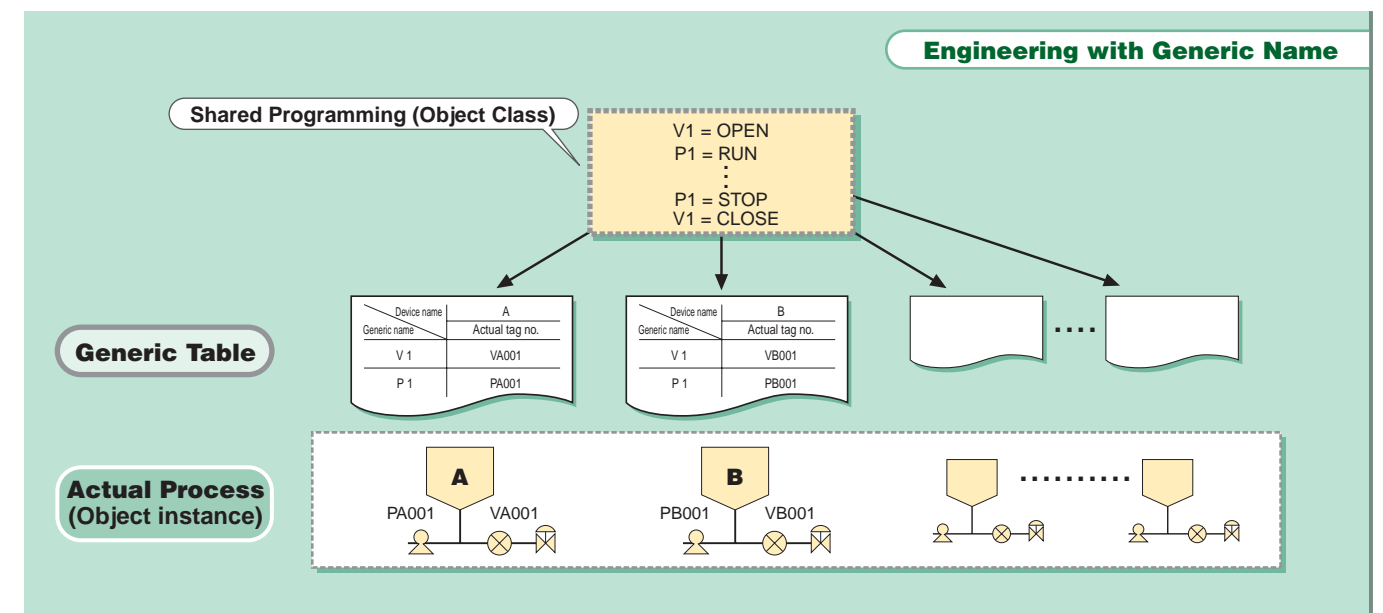

Powerful and Advanced Unit Supervision

Traditionally, operation and monitoring have been performed individually for each piece of equipment, but centralized supervision of unit instruments can greatly simplify plant operations.

A state transition matrix is built into unit instruments enabling each unit to have a unique set of states, commands and state transitions. The CENTUM VP provides a fully integrated operation and monitoring environment that allows operation and monitoring to be tailored to equipment configurations.

A batch process typically consists of multiple pieces of equipment (e.g., reactor, mixing tank, or spray dryer). Each unit has multiple equipment and control modules such as temperature sensors, pumps, and valves, which must be centrally controlled by unit supervision. In CENTUM VP, unit instruments are used to centrally control the various, independent, equipment and control modules that make up a unit.



Your Challenge

Use our own state names and transition conditions for units, we don't want to be constrained by the vendor's generic standard.



Yokogawa's Solution

You can define your own state transition matrix containing process and industry specific state and command names and transition logic.

The state transition matrix built into every CENTUM VP unit instrument provides a standard set of command, states and transition logic to speed engineering. The default commands/states include start/restart/running, pause/paused, and suspend/suspended. Built-in state transition logic is easily configured to allow restarting unit procedures after exceptions have been handled; options include restarting from where the exception occurred, from the start of the previous phase or operation or from the start of the next phase or operation.

When the standard does not fit your needs you may simply build your own state transition matrix giving units unique state and command names and transition logic. For example in regulated industries you can easily configure the system so some units have state names such as "Clean", "Dirty" and "Expired" with custom transition logic. When this is done, the system's standard event log will record unit state transitions using your terminology, not a generic standard term that does not fit your application.

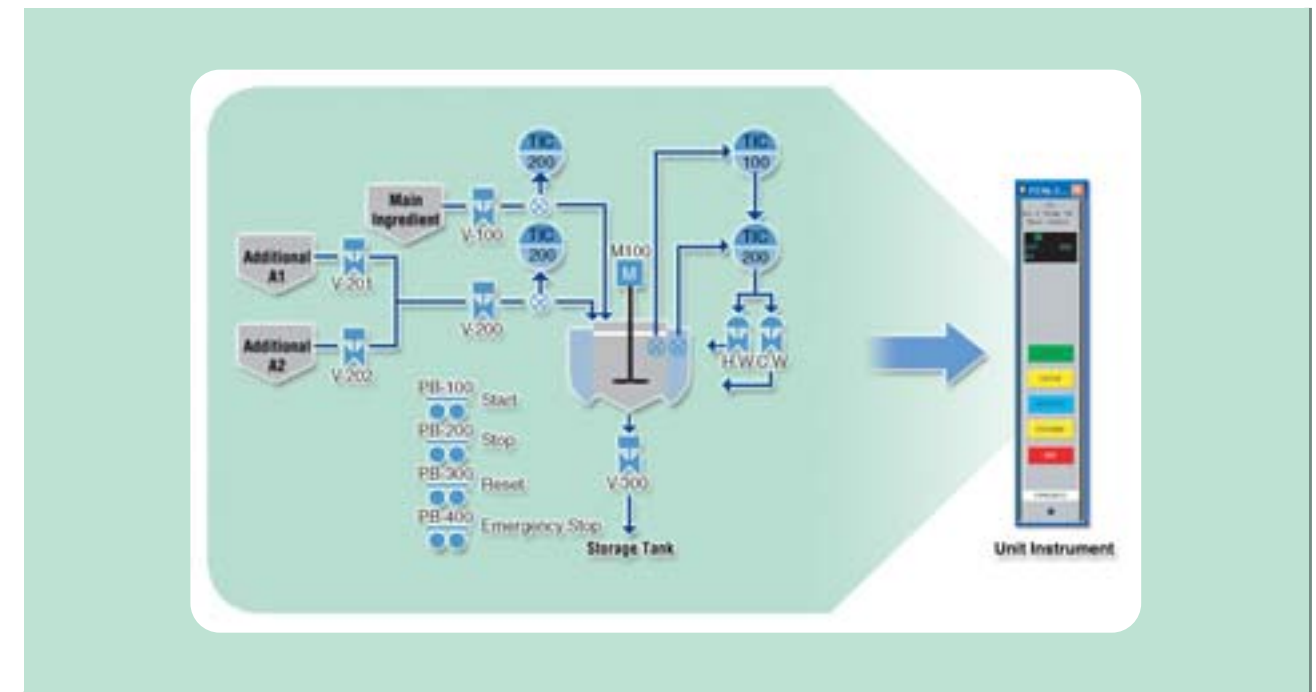

Your Challenge

Reduce the time and cost required to implement exception logic.



Yokogawa's Solution

Exception handling, including detection of failures, interrupt processing, and continuous monitoring routines can be simply plugged into your control strategies.

It usually takes many engineering man-hours to develop sequence control for exception handling and interrupt processing for batch control. The unit supervision function in CENTUM VP allows these routines to be easily plugged in as required by the process.



Your Challenge

Regulatory requirements and/or company policy require records of changes to configuration data be kept.



Yokogawa's Solution

Audit trails are supported for configuration changes.

To comply with regulations, such as the FDA's 21 CFR Part 11 and good engineering and software practices, CENTUM VP records and retains audit trails for engineering configuration and recipe data. When required electronic signatures may be used as evidence of who made.

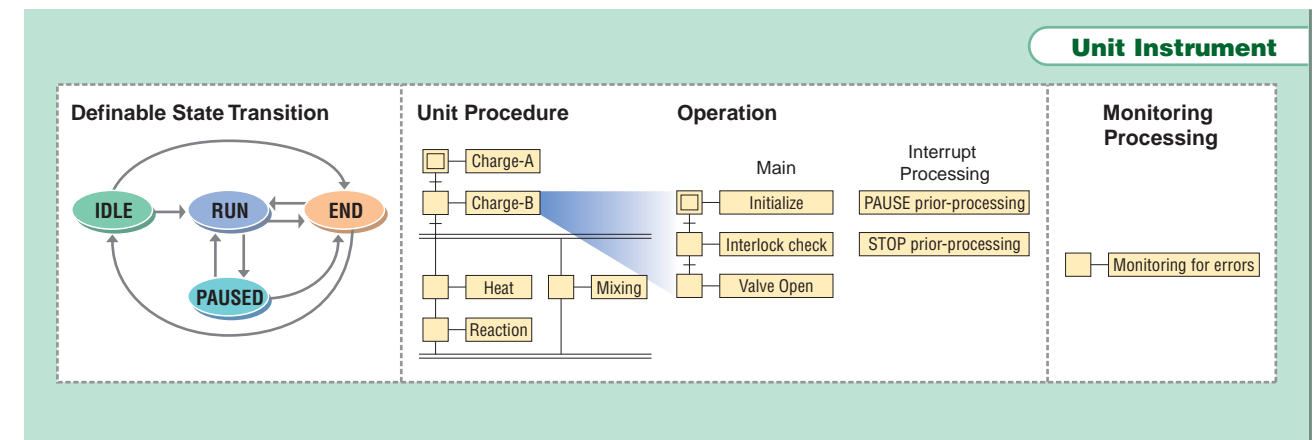

Easy Operation

The control of batch processes often involves many manual operations such as manual additions, starting/stopping equipment and activities operators must perform on the production floor. Often it is difficult to coordinate automatic control system activities and manual operator activities. The CENTUM VP offers a simple, clear operating and monitoring scheme with hierarchical display windows, interactive guidance for on-site operations, and many other features to make life easier for operators.

? Your Challenge

Allow the operators to intuitively grasp the statuses of running processes.

! Yokogawa's Solution

Sequential Function Charts (SFC) visually represent the statuses of individual unit procedures, operations and phases.

Operators can follow the progress of unit procedures, operations and phases in real-time, automatically configured displays. The display windows are hierarchically organized with a navigator window allowing easy access to the desired window.



? Your Challenge

There are many local operations, which are difficult to coordinate with automatic control.

! Yokogawa's Solution

System coordination of manual operations and automatic sequences.

Mobile terminals such as Microsoft Windows Mobile-based PDAs can be used as production floor terminals to perform the same operations as if in the central control room. In addition, using interactive messages (appearing as dialog boxes), work instructions can be sent to operators no matter their location. These dialog boxes are able to provide acknowledgement of received messages as well as provide data entry. This functionality lets manual operations be easily coordinated and integrated with automatic sequences.

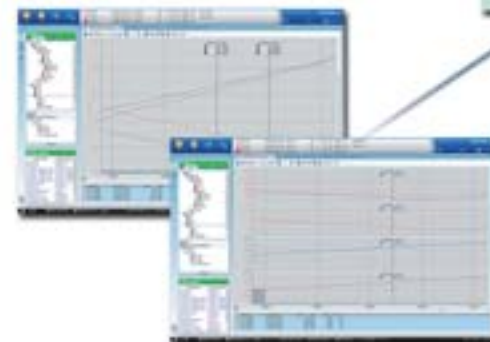

? Your Challenge

Meeting the challenges of pharmaceutical manufacturing regulations such as audit trails and electronic records & signatures.

! Yokogawa's Solution

Audit trails and electronic signatures applicable to operations

Depending on the operator's level of security clearance, security restrictions can be set in detail for monitoring, using display windows, display terminals, process equipment, and the like, as well as for actions on each equipment and control module. The user name and password must be entered for authentication by electronic signature when logging on to the system or performing an action on equipment. Double authentication supporting done-by/checked-by requirements can be set for critical operations. User actions are automatically time-stamped, recorded, and retained as operational audit trails. Yokogawa is committed to provide customers in regulated industries with products and services to help them comply with the FDA's 21 CFR Part 11 regulation for pharmaceutical manufacturing.



Electronic Batch Records

Control systems produce large amounts of operational results that are vital for making business decisions concerning productivity, quality, and safety improvements. Exaquantum/Batch, a Batch Plant Information Management system (Batch PIMS), automatically saves all VP Batch batch history information to an open, ISA-88 based, relational database. It features functions to automatically log the manufacturing results of process management and unit supervision, consumption of raw materials, alarms occurring in manufacturing, and many more, all of which can easily be displayed.

? Your Challenge

Create batch reports containing batch operational data.

! Yokogawa's Solution

You can generate batch reports easily using Microsoft Excel.

Using the CENTUM VP Report Package (a plug-in for Microsoft Excel), you can easily generate batch reports that include formula target values, actual values, batch trends, alarm and event logs, including records of operator actions, associated with a batch and much more. Standard report templates are provided to facilitate easily building your batch reports.

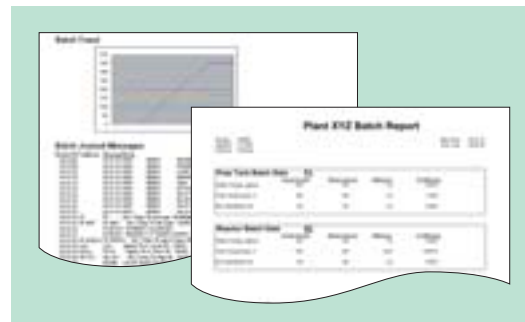

? Your Challenge

Preserve operational batch, product and equipment data to use in continuous improvement programs.

! Yokogawa's Solution

Exaquantum/Batch not only automatically collects and stores operational batch data it also preserves master recipes and changes to the plant equipment hierarchy using the complete data set for automatic analysis of your plant's productivity and efficiency.

As systems become more automated, operational efficiency and quality are expected to improve, but it is crucial that managers use this data effectively. Exaquantum/Batch provides a standard set of analysis tools that automatically provides metrics that can be used to measure operational excellence for batch operations, equipment utilization and product development. These critical measurements enable you and your colleagues to quickly identify areas for improvement. With Exaquantum/Batch, you do not need to define the data you want to be acquired; instead, batch history data is acquired, analyzed and displayed automatically. Exaquantum/Batch is ready to go immediately after installation.

Examples of reporting and analytical capabilities include:

- Integrated batch reports that can be customized for each master recipe, or recipe family
- Unit utilization automatically calculated
- Events and alarms compared on a batch relative basis
- Gantt charts displaying batch execution in real-time and in batch relative time
- Batch Production performance ratings automatically calculated for each batch and rolled up on a master recipe basis
- Cycle times with mean and standard deviation automatically calculated and displayed for each batch and unit recipe

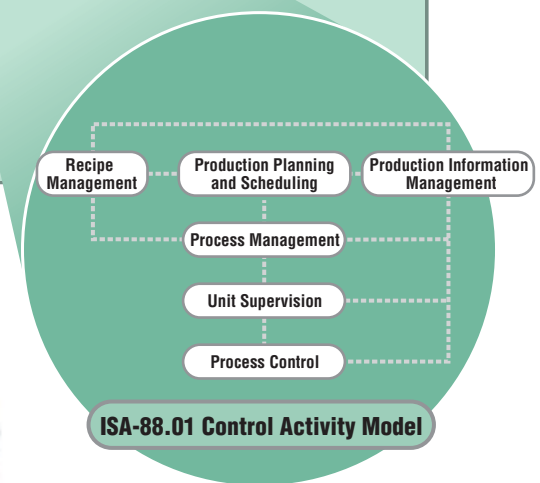
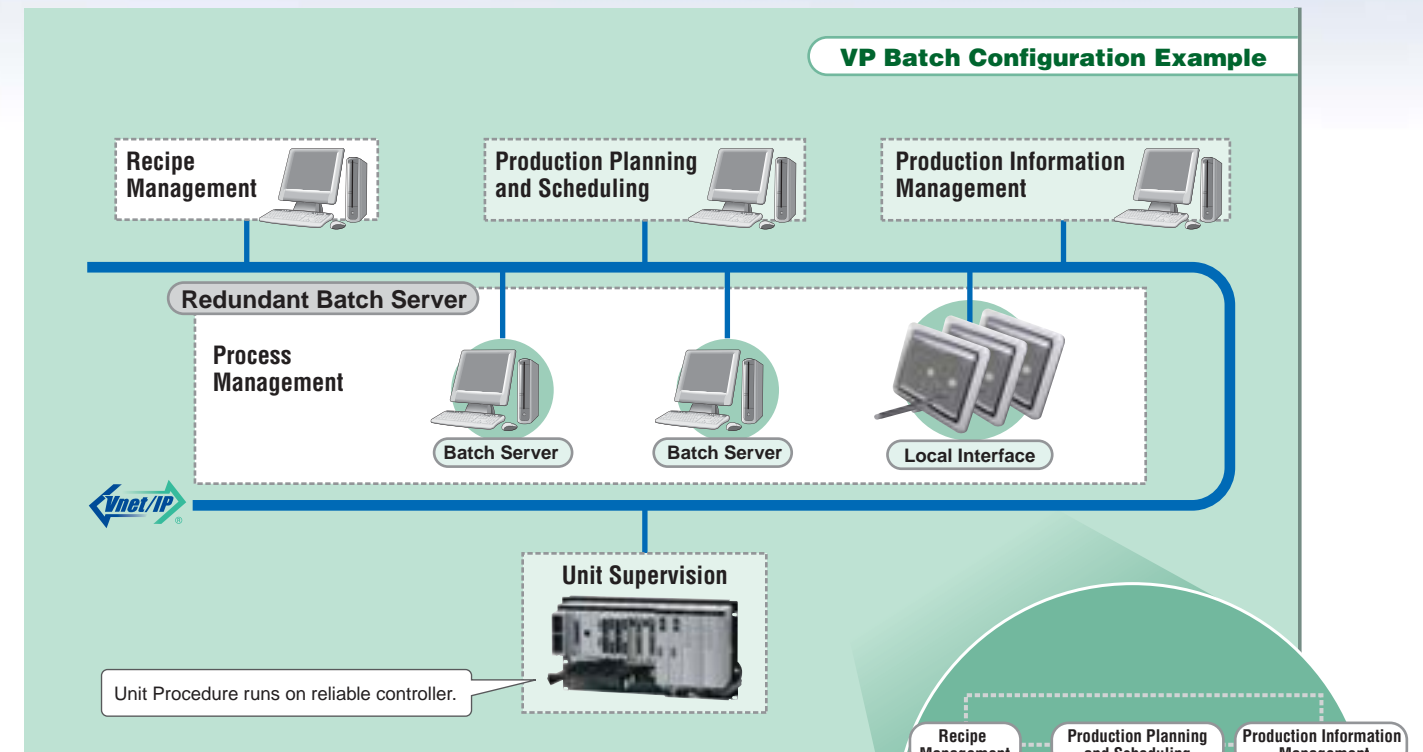

Intelligent Solution Suites

VP Batch and Exaquantum/Batch provide the basis for a plant and enterprise-wide integrated information system configured to meet the specific requirements of the batch processing industries. Based upon the ISA-95 Enterprise-Control System Integration standard Yokogawa can provide integrated Manufacturing Execution Systems (MES) that involve simple integration of Yokogawa or other manufacturers' products, up to fully integrated solutions consisting of intelligent field instruments, automated batch control integrating manual operations, recipe management, production planning and scheduling and batch production information management.

Recipe Management

VP Batch provides recipe management functions for creating and managing master recipes. The master recipes have the advantage of being unit-independent. With VP Batch, process engineers can develop master recipes independently of unit configurations and without the aid of a system engineer. Simply by using a PC, master recipes can be tested and verified with Yokogawa's unique virtual test function, thus reducing time to market. VP Batch master recipes can be integrated with peer batch control systems, MES systems and enterprise systems.

Production Planning and Scheduling

Batch systems must now be able to manufacture different products in varying volumes, with frequent interruptions of orders or changes of product being manufactured. The systems must, therefore, accurately comprehend production plans and the current state of progress, and react quickly to changes. The VP Batch schedule interface enables your preferred scheduling package to be integrated with your batch control system.

Batch Production Information Management *Exaquantum|Batch*

Exaquantum/Batch is an intelligent ISA-88 based Batch Information System. It provides analysis and reporting facilities that collect, store and display current and historical data from batch production, equipment and recipe viewpoints. This enables easy user access to batch information for decision support, production planning, production scheduling, analysis, process improvement, quality and legislative compliance purposes including using ISA-95 to exchange data with your business systems.

Asset Management - Plant Resource Manager *PRM*

PRM (Plant Resource Manager) collects diagnostic information from field devices through various fieldbus networks, such as Foundation Fieldbus and HART, and manages the information in unified databases. With these databases, maintenance schedules can be planned allowing work procedures and spare parts to be managed efficiently. Field devices can be centrally managed thanks to systematic predictive maintenance, reducing TCO and maximizing process up time.

Alarm Management *AAASuite*

AAASuite is an advanced alarm administrator designed to address issues with alarm settings of control modules. Specifically with batch process, alarm settings need to be dynamically set according to the status of the batch. AAASuite provides enabling and disabling of alarms according to operation and phase in order to reduce known nuisance alarming that would be caused by normal operation.

Operation Efficiency Improvement Package *Exapilot*

Exapilot improves the operation efficiency by standardizing and automating the operation procedures based on the expertise of experienced operators.

Event Analysis Package *Exaplog*

Exaplog graphically analyzes historical messages in the production control system that contain all the plant operations, in order to locate nuisance alarms and inefficient operation sequences, and thus improve production processes.

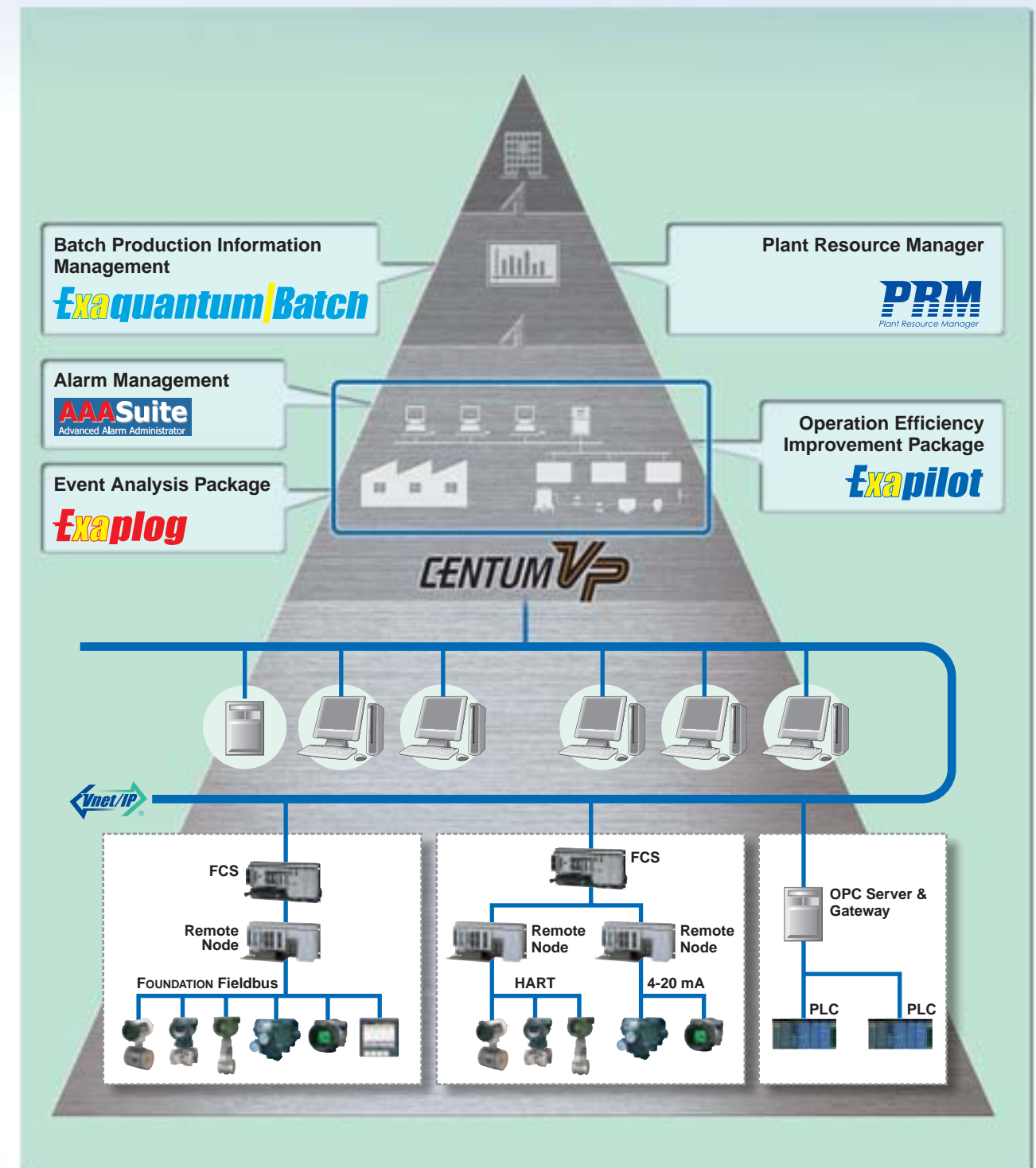



Yokogawa's batch solutions are field-proven worldwide in a wide range of batch processes and industries including fine chemicals, pharmaceuticals, food & beverage, and pulp & paper, to name just a few.

Yokogawa works in partnership with users to boost productivity and profitability, increase reliability and quality, reduce time-to-market, and increase efficiency. Our experienced staff offers skilled, comprehensive support encompassing improvements of single units, updates to existing plants, and design for and operation of new plants. We are not just another supplier, but your trusted partner and provider of solutions.

CENTUM, Vnet/IP, PRM, Exapilot, Exaquantum, Exaplog, Exaopc, AAASuite, vigilance and vigilantplant are either trademarks or registered trademarks of Yokogawa Electric Corporation. Windows is a registered trademark of Microsoft Corporation in the U.S. and other countries. Ethernet is a registered trademark of XEROX Corporation. FOUNDATION in "FOUNDATION Fieldbus" and the logo mark of Fieldbus Foundation are registered trademarks of the Fieldbus Foundation. HART and the logo mark of HART are registered trademarks of the HART Communication Foundation. PROFIBUS and the logo mark of PROFIBUS are registered trademarks of PROFIBUS International. Modbus is a registered trademark of Modbus Organization, Inc. DeviceNet and the logo mark of DeviceNet are registered trademarks of ODVA. Other company and product names in this bulletin are trademarks or registered trademarks of their respective holders (the ™ or ® mark is not displayed).



Yokogawa is a founding sponsor of the World Batch Forum, an organization which promotes best practices in batch automation through education and conferences. See www.wbf.org

vigilantplant.®

The clear path to operational excellence

SEE
CLEARLY

KNOW
IN ADVANCE

ACT
WITH AGILITY

VigilantPlant is Yokogawa's automation concept for safe, reliable, and profitable plant operations. VigilantPlant aims to enable an ongoing state of Operational Excellence where plant personnel are watchful and attentive, well-informed, and ready to take actions that optimize plant and business performance.

YOKOGAWA ELECTRIC CORPORATION

World Headquarters

9-32, Nakacho 2-chome, Musashino-shi, Tokyo 180-8750, Japan
<http://www.yokogawa.com/>

YOKOGAWA CORPORATION OF AMERICA

12530 West Airport Blvd, Sugar Land, Texas 77478, USA
<http://www.yokogawa.com/us/>

YOKOGAWA EUROPE B.V.

Euroweg 2, 3825 HD Amersfoort, The Netherlands
<http://www.yokogawa.com/eu/>

YOKOGAWA ENGINEERING ASIA PTE. LTD.

5 Bedok South Road, Singapore 469270, Singapore
<http://www.yokogawa.com/sg/>

YOKOGAWA CHINA CO., LTD.

3F TowerD Cartelo Crocodile Building
No.568 West Tianshan Road, Shanghai 200335, China
<http://www.yokogawa.com/cn/>

YOKOGAWA MIDDLE EAST B.S.C.(c)

P.O. Box 10070, Manama
Building 577, Road 2516, Busaiteen 225, Muharraq, Bahrain
<http://www.yokogawa.com/bh/>

Represented by:

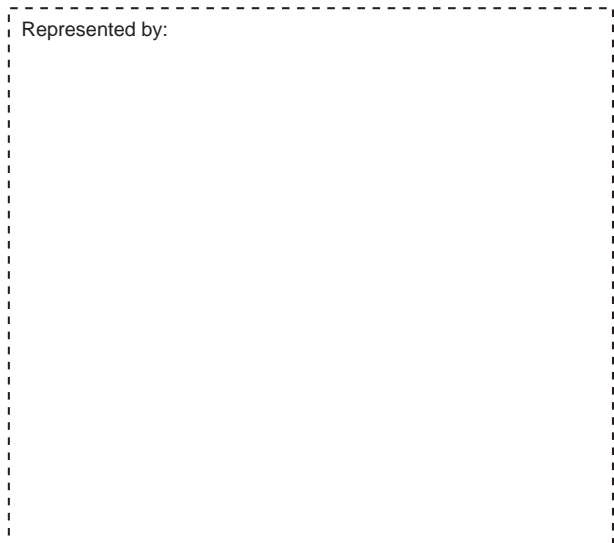

Printed in Japan, 010(KP) [Ed : 04/b]