

761922

Harmonic/Flicker Measurement Software



Supports Your Needs from Low Frequency EMC Testing to Creating Reports

- Supports harmonic and voltage fluctuation/flicker standards tests of the IEC and the JIS for single/three-phase applications.*
 - Harmonics
 - EN61000-3-2 / IEC61000-3-2
 - JIS C 61000-3-2
 - EN61000-3-12 / IEC61000-3-12
 - Voltage fluctuation/flicker
 - EN61000-3-3 / IEC61000-3-3
 - EN61000-3-11 / IEC61000-3-11
- Supports the WT3000 Precision Power Analyzer with the /G6, /FL and /FQ options

*Investigate by Yokogawa, as of June, 2012

Reduces Time Spent on Low Frequency EMC Standard Research and Evaluation

The measurement procedures and settings for harmonic/flicker standards testing have been precisely defined. Engineers must also stay current with the specialized knowledge and up-to-date information required to periodically review the contents of the standards and perform the standards conformance tests. The model 761922 Harmonic/Flicker Measurement Software enables engineers without specialized knowledge to perform a range of operations using the WT3000 Precision Power Analyzer including judging standards compliance and outputting test reports.

Supported Standards

• Harmonics

EN61000-3-2 / IEC61000-3-2

Limits for harmonic current emissions (Equipment rated current ≤ 16 A per phase)

EN61000-3-12 / IEC61000-3-12

Limits for harmonic current emissions (16 A < Equipment rated current ≤ 75 A per phase)

JIS C 61000-3-2

Limits for harmonic current emissions (Equipment rated current ≤ 20 A per phase)

• Voltage fluctuation/flicker

EN61000-3-3 / IEC61000-3-3

Limitation of voltage fluctuations and flicker
(Equipment rated current ≤ 16 A per phase and not subject to conditional)

EN61000-3-11 / IEC61000-3-11

Limitation of voltage fluctuations and flicker supply systems
(Equipment rated current ≤ 75 A and subject to conditional)

Wiring

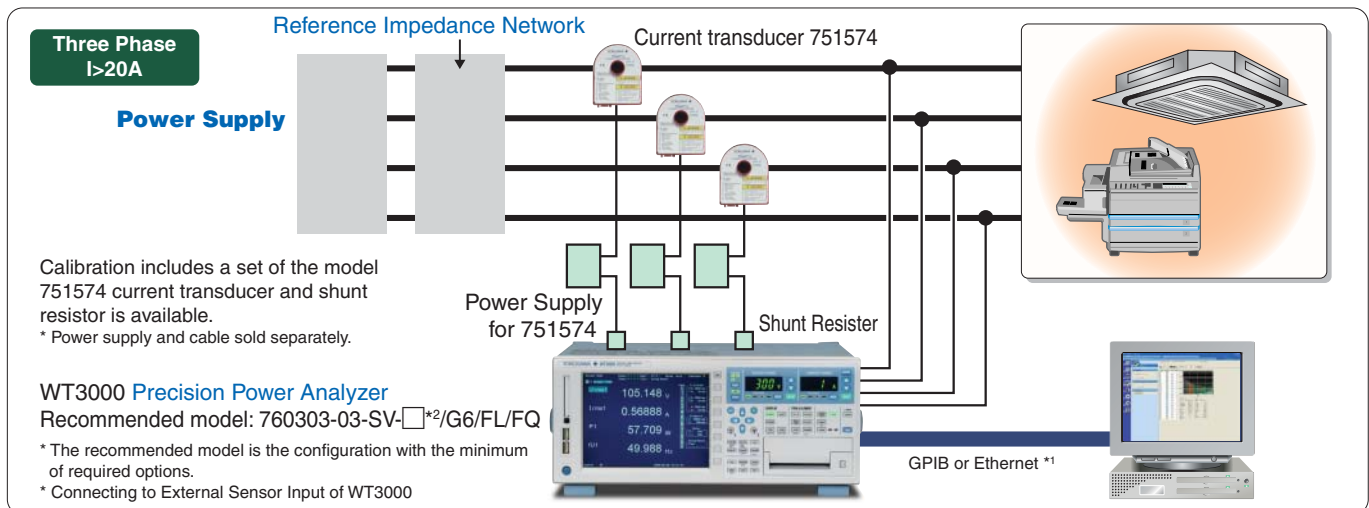
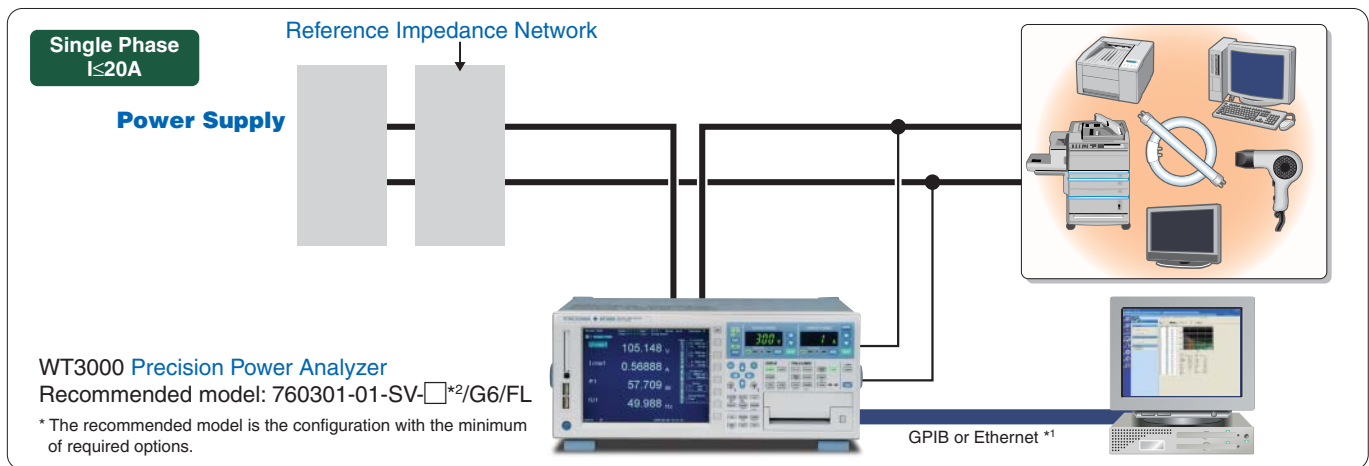

*1 Need /C7 option with WT3000

*2 Power Cord D, F, R, Q or H

Note Significance of Low Frequency EMC Standards Testing

Harmonic Current

Harmonic current is generated by condenser input type switching mode power supplies and other sources. Proliferation of these types of power supplies has resulted in harmonic distortion in the commercial power supply that can cause problems such as equipment malfunction and heating of the condensers in the power supply system. Because of this, international standards have been established for equipment that emits harmonic currents.

Voltage Fluctuation/Flicker

When large currents flow in running equipment, impedance in the power system causes the power supply voltage to drop. Because the brightness of

an incandescent light bulb is proportional to the square of the power supply voltage, this voltage drop causes the bulb to flicker. The voltage fluctuation/flicker standards were enacted to reduce this undesirable flicker.

•Enforceability

A consistent level of stability is required of products shipped to the EU market, and the governments of the EU must conform their laws to the EC directives. These directives include the Machinery Directive, EMC Compatibility Directive, and Low Voltage Directive. The items of the EMC directive include a low frequency EMC standard. Most products shipped to the EU for sale to the general consumer are subjected to low frequency EMC standards testing, and they must be checked to ensure that they are within the limits defined by the standard.

Standards Testing

Harmonics

● Class judgment screen Supports IEC/JIS standards

You can specify class A, B, C, or D according to the DUT. Pass or Fail is automatically determined based on the judgment criteria for the specified class.

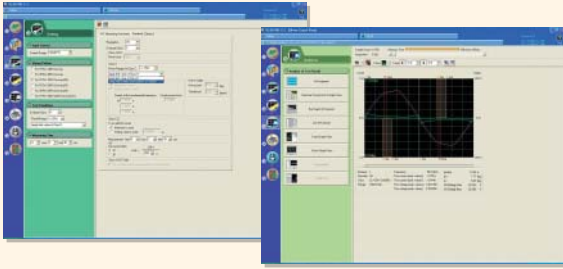

Supports the judgement by wave shape

● Measured results screen List/bar graph displays

You can easily ascertain the harmonic level of the measured data relative to the limits of the standard. Test results are color coded for easy visual identification (blue: within limits; red: exceeding limits).

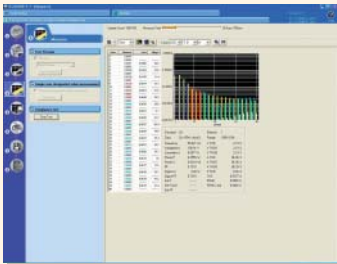

Judgments incorporating mitigating conditions such as POHC can be displayed in a graph

● Trend display Displays harmonic current in a time series

Displays all harmonic measurement results in a time series by order. You can check all measured results at once, allowing you to identify the timing at which limits were exceeded.

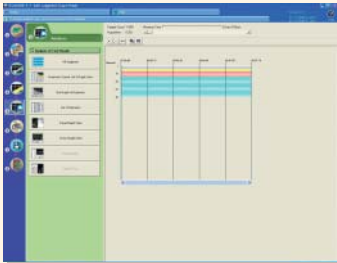

● Support for IEC61000-3-12

Supports calculation of the rated power S_{sc} and short-circuit ratio R_{sc} and judgement.

Voltage Fluctuation/Flicker

● Measured results screen

You can measure data required for flicker standards testing (including the relative steady-state voltage change d_c , maximum relative voltage change d_{max} , time at which relative voltage change exceeds threshold $d(t)$, short-term flicker value P_{st} , and long-term flicker value P_{lt}) and check the results (data and Pass/Fail) in a list.

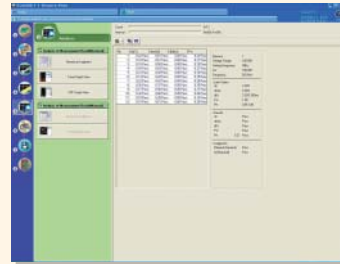

● CPF graph display

You can determine the flicker level probability density function from the instantaneous flicker sensation (IFS), and display the cumulative probability function (CPF) representing cumulative flicker levels above a certain value. You can visually confirm the state of the flicker's fluctuations.

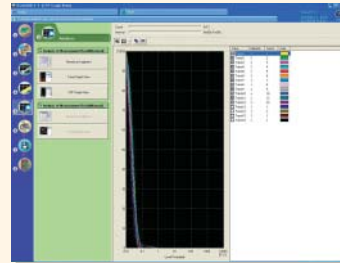

● Trend display Time series display of each parameter

The time series voltage fluctuations can be shown in trend displays which are useful in creating countermeasures against flicker.

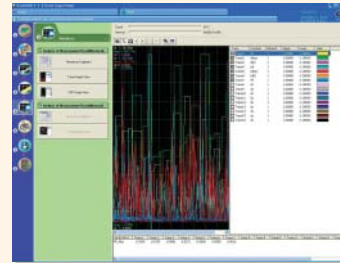

● Support for IEC61000-3-11

Supports tests of supply current capacities of 100 A or more. You can set a Ztest value and convert results.

Report

Results of harmonic/flicker measurements can be displayed in a numerical list or graph, printed, or saved as screen images. Values needed for judgments or reports can be displayed (in English) and used as-is in test reports.

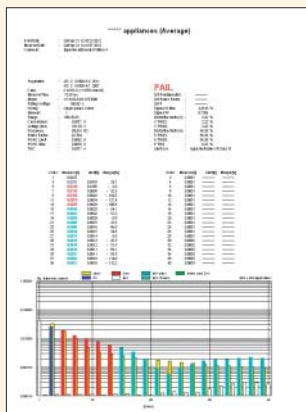

Harmonic judgment report (average value)

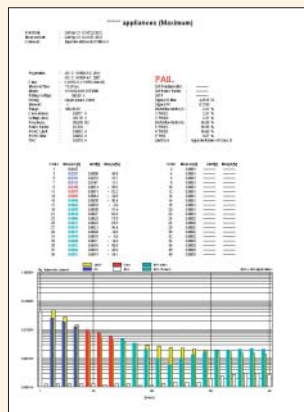

Harmonic judgment report (max. value)

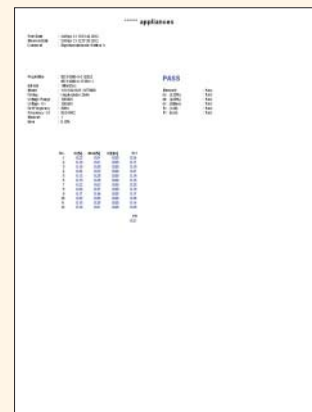

Voltage fluctuation/flicker judgment report

Precision Power Analyzer WT3000

• IEC Harmonic Measurement

| Item | Specifications |
|---------------------------|---|
| Measured source | Select an input element or an Σ wiring unit |
| Format | PLL synchronization method |
| Frequency range | Fundamental frequency of the PLL source is in the range of 45 Hz to 66 Hz. |
| PLL source | <ul style="list-style-type: none"> Select the voltage or current of each input element (external current sensor range is greater than or equal to 500 mV) or the external clock (fundamental frequency). Input level <ul style="list-style-type: none"> Greater than or equal to 50% of the measurement range rating when the crest factor is 3 Greater than or equal to 100% of the measurement range rating when the crest factor is 6 Be sure to turn the frequency filter ON. |
| Window length | 10 cycles at 50 Hz 12 cycles at 60 Hz |
| Processing word length | 32 bits |
| Window function | Rectangular |
| Anti-aliasing filter | Set using a line filter (5.5 kHz). |
| Interharmonic measurement | Select OFF, Type1, or Type2. |

• Normal Flicker Measurement Mode

| Item | Specifications |
|---|---|
| Measurement Items (Measurement Functions) | dc Relative steady-state voltage change dmax Maximum relative voltage change d(t) The time during which the relative voltage change during a voltage fluctuation period exceeds the threshold level The maximum value within a observation period is displayed for the items above. Pst Short-term flicker value Plt Long-term flicker value |
| One observation period | 30 min to 15 s |
| Observation period count | 1 to 99 |

• Measurement of dmax Caused by Manual Switching Mode

| Item | Specifications |
|-------------------------------------|---|
| Measurement (Measurement Functions) | dmax Maximum relative voltage change |
| One observation period | 1 minute |
| Observation period count | 24 |
| Averaging | Average of 22 measured dmax values excluding the maximum and minimum values among 24 values |

| Model | Suffix Codes | Description |
|----------------|------------------------------|---|
| 760301 | | WT3000 1 input element model |
| 760302 | | WT3000 2 input elements model |
| 760303 | | WT3000 3 input elements model |
| 760304 | | WT3000 4 input elements model |
| Element number | -01 | 30A input element |
| | -02 | |
| | -03 | |
| | -04 | |
| | -10 | 2A input element |
| | -20 | |
| | -30 | |
| | -40 | |
| Version | -SV | Standard Version |
| | -MV | Motor Version |
| Power cord | -D | UL/CSA standard |
| | -F | VDE standard |
| | -R | AS standard |
| | -Q | BS standard |
| | -H | GB standard |
| Options | /G6 | Advanced Computation (IEC standard testing*, harmonic, FFT, Waveform computation) |
| | /B5 | Built-in Printer |
| | /DT | Delta Calculation |
| | /FQ | Add-on Frequency Measurement |
| | /DA | 20ch D/A output |
| | /V1 | VGA Output |
| | /C2 | Serial (RS-232) Interface |
| | /C12 | Select one USB port (PC) |
| | /C5 | USB port (Peripheral) |
| | /C7 | Ethernet function |
| /CC | Cycle by Cycle | |
| /FL | Voltage Fluctuation, Flicker | |

* For Voltage fluctuation and Flicker measurement of three phase device, /G6, /FL and /FQ options are required.

Harmonic/Flicker Measurement Software 761922

| Harmonics | Harmonic measurement/judgment software that can measure harmonic currents and judge the results of those measurements based on IEC standards. Displays and prints measurements and judgments. The software's executable file name is IEC61000.exe. | | | | | | | | | | | | | | | | | | | | | | | | |
|---------------------------------|---|-------------------|-------------------|-------------------|-------------|--------------|-------------|------------|-------------------|-------------------|-------------------|-------------------|-------|---------------|-------|-------|---------------|---------------|-------|-----------|-------|-------|---------------|---------------|-------|
| Compatible measurement devices* | WT3000 (Models 760301, 760302, 760303, and 760304) | | | | | | | | | | | | | | | | | | | | | | | | |
| Applicable standards* | IEC 61000-3-2 (Electromagnetic compatibility (EMC) - Part 3-2: Limits - Limits for harmonic current emissions (equipment input current 16 A per phase)) Edition 3.0 and A2 of the Edition 3.0 • EN61000-3-2:2006/A2:2009 • IEC61000-4-7 Edition 1.0, Edition 2.0, A1 of the Edition 2.0 • JIS C61000-3-2:2011, abbreviated as JIS • JIS C61000-4-7:2007 • The IEC 61000-3-12 First Edition harmonic current emission standard • EN 61000-3-12 (2005) * The width of the window function (measurement period) for measurements on the WT3000 is the same as defined by IEC61000-4-7 or JIS C 61000-4-7. | | | | | | | | | | | | | | | | | | | | | | | | |
| Voltage fluctuation and Flicker | The voltage fluctuation and flicker measurement software measures the voltage fluctuation and flicker of electrical or electronic equipment according to the IEC Standard and indicates/saves the results of judgments made according to the standard. The executable file name is IEC61000.exe. | | | | | | | | | | | | | | | | | | | | | | | | |
| Applicable instruments | WT3000 (models 760301, 760302, 760303, and 760304) | | | | | | | | | | | | | | | | | | | | | | | | |
| Applicable standards | Voltage fluctuation and flicker suppression standards • IEC 61000-3-3 Edition 2.0:2008 • EN 61000-3-3:2008 • IEC 61000-3-11 Edition 1.1:2000 • EN 61000-3-11:2000 Flicker meter function and design specifications • IEC 61000-4-15 Edition 1.1:2003 • EN 61000-4-15:1998, EN 61000-4-15A1:2003 • IEC 61000-4-15 Edition 1.1:2003 • EN 61000-4-15:1998, EN 61000-4-15A1:2003 | | | | | | | | | | | | | | | | | | | | | | | | |
| PC system requirements | PC • CPU Pentium 4 1.5 GHz or higher (recommended) • Memory 1 GB or more (recommended) • Hard disk 500MB or more of free space Operating system An English version of Microsoft Windows: Windows XP, Windows Vista ¹ , or Windows 7 ¹ . *1 Both 32-bit versions and 64-bit versions are supported. | | | | | | | | | | | | | | | | | | | | | | | | |
| Communications card | • GP-IB One of the following GPIB boards or cards by National Instruments. You will need the driver version that is listed below for your OS or a later version (NI-488.2). | | | | | | | | | | | | | | | | | | | | | | | | |
| | <table border="1"> <thead> <tr> <th></th> <th>PCI-GPIB</th> <th>PCI-GPIB+</th> <th>PCMCIA-GPIB</th> <th>PCMCIA-GPIB+</th> <th>GPIB-USB-HS</th> </tr> </thead> <tbody> <tr> <td>Windows XP</td> <td>1.60²</td> <td>1.60²</td> <td>1.60²</td> <td>1.60²</td> <td>2.8.1</td> </tr> <tr> <td>Windows Vista</td> <td>2.7.2</td> <td>2.7.2</td> <td>not supported</td> <td>not supported</td> <td>2.8.1</td> </tr> <tr> <td>Windows 7</td> <td>2.7.2</td> <td>2.7.2</td> <td>not supported</td> <td>not supported</td> <td>2.8.1</td> </tr> </tbody> </table> *2 however, version 2.3 is not supported. | | PCI-GPIB | PCI-GPIB+ | PCMCIA-GPIB | PCMCIA-GPIB+ | GPIB-USB-HS | Windows XP | 1.60 ² | 1.60 ² | 1.60 ² | 1.60 ² | 2.8.1 | Windows Vista | 2.7.2 | 2.7.2 | not supported | not supported | 2.8.1 | Windows 7 | 2.7.2 | 2.7.2 | not supported | not supported | 2.8.1 |
| | PCI-GPIB | PCI-GPIB+ | PCMCIA-GPIB | PCMCIA-GPIB+ | GPIB-USB-HS | | | | | | | | | | | | | | | | | | | | |
| Windows XP | 1.60 ² | 1.60 ² | 1.60 ² | 1.60 ² | 2.8.1 | | | | | | | | | | | | | | | | | | | | |
| Windows Vista | 2.7.2 | 2.7.2 | not supported | not supported | 2.8.1 | | | | | | | | | | | | | | | | | | | | |
| Windows 7 | 2.7.2 | 2.7.2 | not supported | not supported | 2.8.1 | | | | | | | | | | | | | | | | | | | | |
| | • Ethernet A 100BASE-TX Ethernet port. | | | | | | | | | | | | | | | | | | | | | | | | |

| Model | Description |
|--------|---------------------------------------|
| 761922 | Harmonic/Flicker Measurement software |

751574

Current Transducer DC to 100 kHz/600Apk

- Wide measurement frequency range: DC and up to 100 kHz (-3 dB)
- High-precision fundamental accuracy: $\pm(0.05\%$ of reading + 40 μ A)
- Wide dynamic range: 0-600 A (DC)/600 A peak (AC)
- ± 15 V DC power supply, connector, and load resistor required.

For detailed information, see Power Meter Accessory Catalog Bulletin CT1000-00E.

Calibration includes a set of the model 751574 current transducer and shunt resistor is available for measurements of 30 A or more. Contact us for details.

Connection Information

The 751574 is used in a one-to-one configuration. Use 1 for single-phase, and 3 for three-phase. Power supply and cable sold separately.

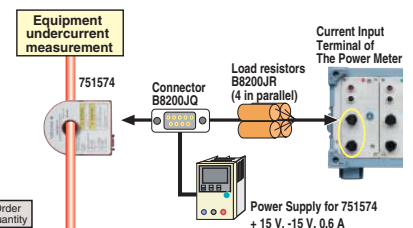

Accessories (sold separately)

| Product | Part no. | Specifications | Order quantity |
|------------------|----------|----------------------------|----------------|
| Output connector | B8200JQ | D-SUB 9-pin, with 2 screws | 1 |

YOKOGAWA

YOKOGAWA METERS & INSTRUMENTS CORPORATION

Global Sales Dept. /Phone: +81-42-534-1413 Facsimile: +81-42-534-1426

E-mail: tm@cs.jp.yokogawa.com

YOKOGAWA CORPORATION OF AMERICA

YOKOGAWA EUROPE B.V.

YOKOGAWA ENGINEERING ASIA PTE. LTD.

Phone: (1)-770-253-7000, Fax: (1)-770-254-0928

Phone: (31)-88-4641000, Fax: (31)-88-4641111

Phone: (65)-62419933, Fax: (65)-62412606

Subject to Change without notice.
 Copyright©2002 Yokogawa Electric Corporation.
 Copyright©2012 Yokogawa meters & Instruments Corporation.

[Ed : 05/b] Printed in Japan, 206(KP)