

**HEAT CALCULATOR
MODEL 212**



|

July 1998

CONTENTS

1. Overview	3
1.1 Model Number Designation	5
1.2 Conversion Factors	6
2. Specification	7
3. Operation	11
3.1 Display Operation	13
3.1.1 Normal Operation	13
3.1.2 Charge/Discharge Operation	17
3.1.3 Peak and Off-Peak Operation	18
3.2 Checking Set-up Parameters	19
3.3 Units of Measurement	24
3.4 Frequency Cut-off	25
3.5 Offset Functions	26
3.6 Operating Modes	27
3.6.1 Heating	27
3.6.2 Cooling	27
3.6.3 Heating/Cooling	27
3.6.4 Charge/Discharge	28
3.7 Peak and Off-Peak	29
3.8 Logging	30
4. Communications	31
4.1 Meter-bus	32
4.2 Infra-red Communications Link	34
4.3 RS485 with Modbus RTU Protocol	35
4.3.1 Hardware	35
4.3.2 Protocol	35
4.3.3 Bus Address	36
4.3.4 Function Codes	37
4.3.5 Exception Response	37
4.3.6 List of Data Registers	38

5. Set-up Mode	44
6. Input & Output Connections	50
6.1 Flowmeter Input	50
6.2 RTD Input	53
6.3 Power Supply	54
6.4 Pulse Output	55
6.5 Alarm Relay Outputs	57
6.6 4-20mA Output Option	59
7. Installation	61
7.1 Wall Mounting	61
7.2 Panel Mount Version	63
7.3 Removing the Front Panel	64
7.4 Verification Seal	66
7.5 Wiring Practices	67
7.6 Terminal Designations	69
Index	70

1. OVERVIEW

The Model 212 Heat Calculator is designed to measure the energy consumed in both heating and cooling (air conditioning) systems. The instrument is normally supplied complete with temperature probes and power supply, and will interface to a wide variety of flowmeters, including positive displacement and inferential water meters, magnetic flowmeters with pulse outputs, turbine flowmeters & paddlewheel flowmeters.

The Model 212 measures the temperature in the feed and return flow lines and uses this information to calculate the density and enthalpy of water. By also measuring the volume of water flowing in the system, the Model 212 will then determine the energy used. Power is calculated as:

$$P = V \times \rho \times (h_{TV} - h_{TR})$$

where P = Power (W)

V = Volumetric Flow rate (m³/sec)

ρ = density (kg/m³)

h_{TV} = Specific Enthalpy (J/kg) at Feed Temperature

h_{TR} = Specific Enthalpy (J/kg) at Return Temperature

The Model 212 is designed to be used in typical water heating or cooling systems where pressures do not exceed 16 bars.

The temperature in both the feed and return lines is measured via two PT100 resistance temperature devices (RTDs). For maximum accuracy, four wire RTD measurement is used and internally corrected for non-linearities which are inherent to an RTD.

The Model 212 complies with OIML R75 and EN1434 standards and includes Meter-bus and an infra-red data transfer option.

The Model 212 includes separate peak and off-peak registers as well as the ability to compute charge and discharge energy in systems where heat may be stored in underground tanks. The Model 212 also includes an RS485 communications link with Modbus RTU protocol.

4 Overview

The Model 212 has a highly accurate built-in real time clock (2ppm typ) to keep track of logging, peak-on/peak-off points, etc. In case of a power failure, the real-time clock is able to keep running for two days with a ± 1 minute accuracy, typically.

This instrument conforms to the EMC-Directive of the Council of European Communities 89/336/EEC and the following standards:

Generic Emission Standard EN 50081-1 Residential, Commercial & Light Industry Environment.

Generic Emission Standard EN 50081-2 Industrial Environment.

Generic Immunity Standard EN 50082-1 Residential, Commercial & Light Industry Environment.

Generic Immunity Standard EN 50082-2 Industrial Environment.

In order to comply with these standards, the wiring instructions in Section 7.5 must be followed.

1.1 MODEL NUMBER DESIGNATION

	Model 212 . 2 0 E 8 S	
Mounting	_____	
Panel Mount	1	
Wall Mount	2	
Options	_____	
No Options	0	
4-20mA Output	1	
Power	_____	
12VDC Power	N	
European Adapter (220 VAC)	E	
UK Adapter (220 VAC)	U	
USA Adapter (110 VAC)	A	
Australian Adapter (240 VAC)	H	
Temperature Sensor	_____	
None	0	
85mm pipe	8	
120mm pipe	1	
210mm pipe	2	
Compliance	_____	
EN1434	S	

6 Overview

1.2 CONVERSION FACTORS

1 kWh	=	3.600 MJ
1 MJ	=	0.27778 kWh
1 m ³	=	1000 litres
1 US gal	=	3.785 litres
1 ft ³	=	7.4805 US gal
1 kBTU	=	1.0551 MJ
1 Ton x Hour (Refrigeration)	=	12,000 BTU
1 therm	=	100,000 BTU

Note: kBTU are used on the Model 212 display and mean BTU x 1000.

2. SPECIFICATION

General

Energy Display units:	kWh, MWh, MJ, GJ, therm, BTU x 1000, tons x hours (refrigeration).
Maximum Thermal Power:	3000 MW.
Accuracy Class:	OIML R75 Class 4, EN1434.
Measurement Time:	0.5 sec time interval.
Environmental Class:	EN1434 Classes A & C.
Ambient Temp Range:	0°C to 60°C.
Storage Temp Range:	-20°C to 70°C.

Temperature Measurement

Type of Sensor:	Pt100 to IEC751.
Temperature Range:	-10°C to 220°C
Temperature Difference:	1K to 200K.
Approved Temp Range:	1°C to 200°C.
Approved Temp Difference:	3K to 199K.
Measurement Time:	3 sec time interval.

Display

Type:	LCD with 7 digit numeric display and 11 character display.
Digits:	15.5mm (0.6") high.
Characters:	6mm (0.24") high.

8 Specification

Flowmeter Input

Type:	Frequency or Pulse between 0.01Hz to 20kHz. Default low frequency cut-off is 0.25Hz.
Signal Type:	Pulse, open collector, reed switch, proximity switch or coil.
K-factor range:	Programmable between 0.001 to 999,999.9 pulse per litre, m ³ , US gallon or ft ³ .
Location:	In either the feed or return lines.

Temperature Sensor (RTD) Input

Sensor Type:	Pt100 to IEC 751.
Connection Type:	Four wire.
Location:	Two RTD inputs, one for the feed and a second for the return lines.
Linearisation:	Built in RTD linearisation.
Temperature Range:	-10°C to 220°C.
RTD Cable Length:	< 50m.

Pulse Out

Pulse Width:	10ms.
Type:	Open collector will sink up to 100mA. 30Vdc Maximum.
Function:	Volume or Energy (scaled).
Frequency:	1 pulse every preset number of units of energy or volume total.

Power Requirements

dc Power:	12 to 24V dc @ 100mA maximum.
ac Power:	Supplied via a power adapter.

Construction

Enclosure Material: ABS/Polycarbonate.
Colour: Light beige.
Protection: Sealed to IP67 (Nema 4X).
Mounting: Wall mounting or panel mounting.
Dimensions: 152mm (6.0") wide x 98mm (3.9") high x 43mm (1.7") deep.

Alarm Output (not available if 4-20mA Output Option is installed)

Type: Two solid state opto-isolated relays which will sink up to 250mA. 30V dc maximum.
Function: High and low alarms individually programmable as unsigned values, for volumetric flow rate, energy flow rate, feed temperature, return temperature or temperature difference.

4-20mA Output Option

Function: Volumetric flowrate, energy flowrate, feed temperature, return temperature or temperature difference.
Output Range: 2.0mA to 22.0mA.
Linearity: 0.02% of span.
Accuracy: 0.1% of span.
Response Time: 0.5 seconds to 99%.
Maximum Output: Vdc -6V.

10 Specification

RS485 Option

Data Transmitted:	Volume and energy totals, peak power, temperatures.
Baud rate:	300 - 9600 baud.
Parity:	Odd, even or none.
Stop bits:	One or two stop bits.
Bus Address:	Programmable for multiple instruments on the same bus.
Protocol:	Modbus RTU.

Meter-Bus

Type:	Conforms to CEN/TC176 Meter-bus standard.
Protocol:	IEC 870-5.

3. OPERATION

The Model 212 has three display modes:

1. Display of normal energy and flow information.

This information is available by pressing the DISPLAY key. Where appropriate Accumulated Totals can be displayed by pressing the ACCUM TOTAL key.

2. Checking Set-up Parameters.

By pressing and holding the DISPLAY key for about 5 seconds, the instrument will enter the parameter set-up routine and allow all set-up parameters to be checked but not changed. The DISPLAY key is used to step through the parameter list.

3. Set-up Parameters.

By removing the bottom cover strip of the instrument (see Section 7), the set-up switch becomes visible. Pressing this switch will put the instrument into the set-up mode, whereby all parameters can be programmed using the DISPLAY, \triangle and \triangleright switches.

The LCD display has 7 numeric digits with 11 alphanumeric characters along the bottom. The alphanumeric characters are used to display the parameter and units.

12 Operation

Three key switches provide the following functions:

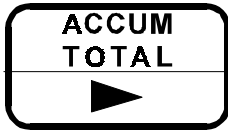

Displays the accumulated (non-resettable) totals for Energy, Volume, operating time (elapsed time) and Energy total for log entries.

Also changes digits, decimal point or units when entering the set-up parameters. A flashing digit, decimal point or unit will indicate that the parameter can be changed.



If the Reset function is enabled during set-up, the RESET key, when held for 5 seconds, will reset all totals and the operating time.

Also increments the digit, changes decimal point position, steps through units when entering set-up parameters and steps through individual log entries.



Used to change the display to the next parameter.

Also steps through display modes when held for 5 seconds.

3.1 DISPLAY OPERATION

3.1.1 Normal Operation

Data which can be displayed by pressing the DISPLAY key is as follows:

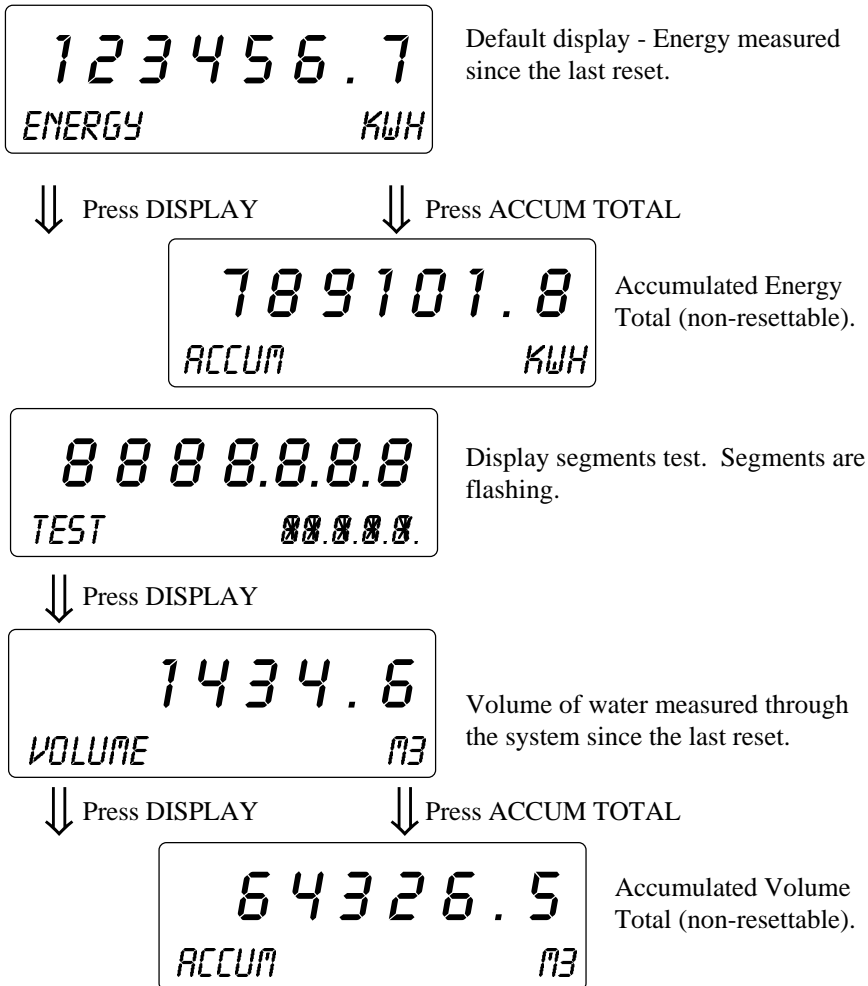

14 Operation

11.2
POWER KW

Energy flow rate

↓ Press DISPLAY

1.193
FLOW M³/H

Volume flow rate

↓ Press DISPLAY

80.6
FEED °C

Temperature in the feed line.

↓ Press DISPLAY

72.3
RETURN °C

Temperature in the return line.

↓ Press DISPLAY

8.3

Difference in temperature between the feed and return lines.

↓ Press DISPLAY

11.6
PEAK P KW

Peak power averaged over a 15 minute period.

↓ Press DISPLAY

126.32
OP TM HR.MIN

Operating time elapsed since the last reset.

↓ Press DISPLAY

↓ Press ACCUM TOTAL

12643.32
ACCUM HR.MIN

Accumulated operating time (non-resettable).

6
SUPPLY

Number of times the power has failed or has been switched off to the unit since the last reset.

↓ Press DISPLAY

18-22
CLOCK H-MIN

Time of day (24 hour clock).

↓ Press DISPLAY

15-07
DATE 1996

Date - Day - Month (SI Units)
Month - Day (US Units)

↓ Press DISPLAY*

14 23.07
TM LOG 1996

Time and date of the last logged entry. Pressing the RESET key will display the previous logged entries.

16 Operation

⇓ Press ACCUM TOTAL

12643.32
EN LOG KWH

Energy Total of selected
log entry.

* *If logging is not used, pressing the DISPLAY key will return to the Energy display.*

3.1.2 Charge/Discharge Operation

If Charge/Discharge operation is programmed, the following display formats will be apparent in place of the normal ENERGY display:

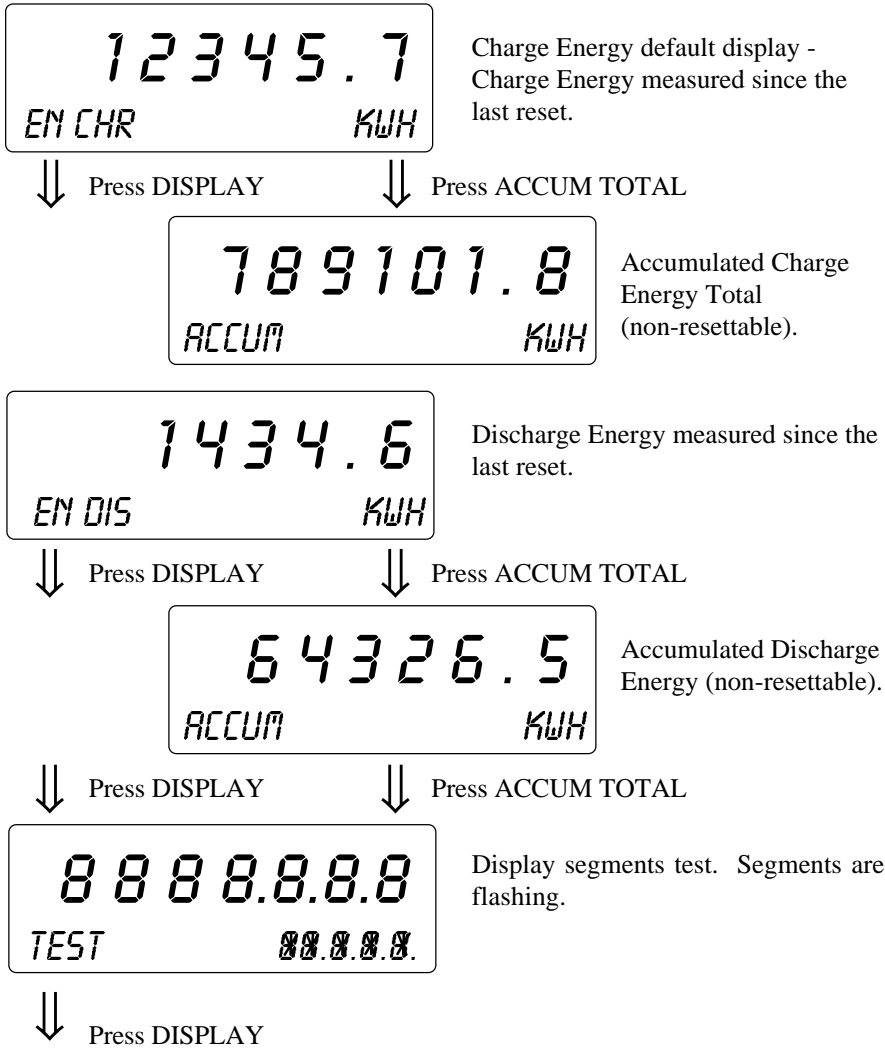

For continuation of displays refer to Section 3.1.1 Normal Operation.

18 Operation

3.1.3 Peak and Off-Peak Operation

If Peak and Off-Peak operation is programmed, the following display formats will be apparent in place of the normal ENERGY display:

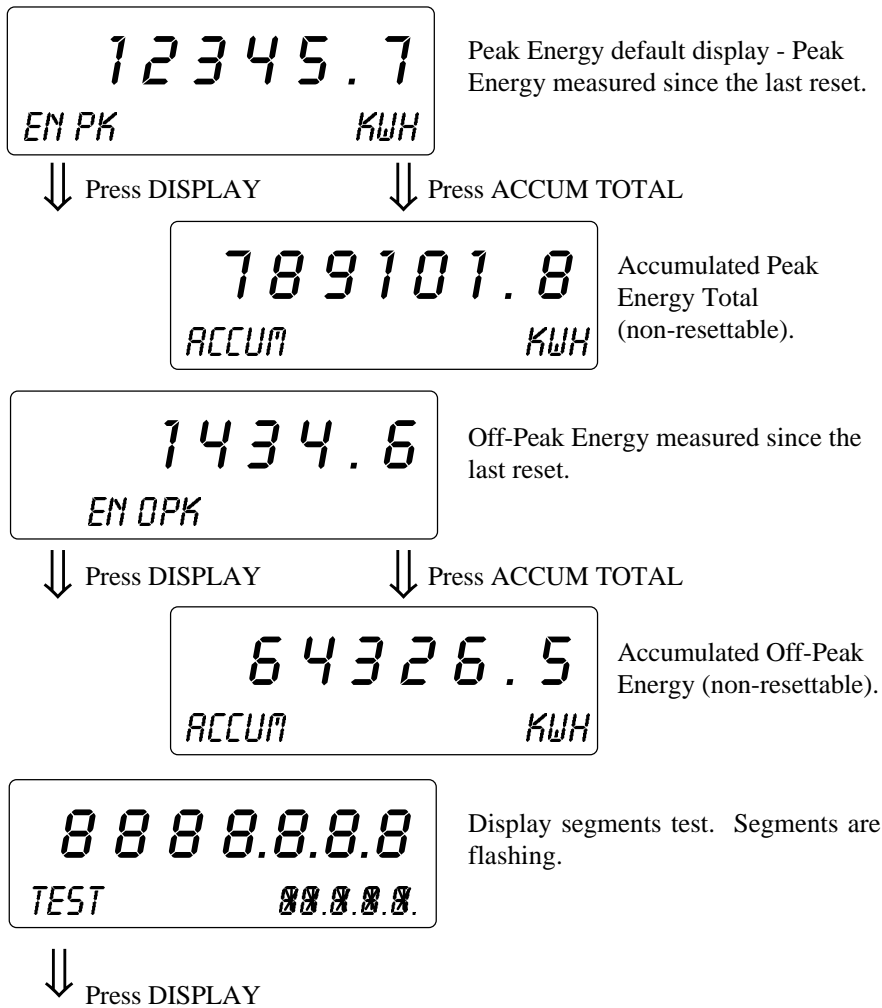

For continuation of displays refer to Section 3.1.1 Normal Operation.

3.2 CHECKING SET-UP PARAMETERS

By pressing the DISPLAY key for 5 seconds, the program will enter the *Check Set-up Parameters* mode. Various set-up parameters can be checked, but not changed, by using the DISPLAY key.

Set-up Mode may be exited by either moving to the last set-up item, QUIT, and selecting YES, or the DISPLAY key may be pressed and held for 5 seconds. After this time, the Model 212 will return to normal operation.

The readout will display the following:

	<i>Parameter</i>	<i>Value</i>	<i>Description</i>
1.	LANG	ENGL GERM	Current language.
2.	MODE	HEAT COOL HT/CL CHAR	Current mode of operation.
3.	UNITS	SI US	Metric units. US units.
4.	FACTOR	xxx.x p/ltr	The K-factor of the flowmeter which has been programmed.
5.	CUTOFF	x.xx Hz	Low frequency cut-off of the flowmeter expressed in Hz. The Model 212 will not register flow if the input frequency is below this value. (Default is 0.25Hz). See Section 3.4.

20 Operation

	<i>Parameter</i>	<i>Value</i>	<i>Description</i>
6.	OFFSET	x.x YES 0.0 NO	The offset between temperature sensors (see Section 3.5). The offset function is disabled.
7.	FM LOC	Feed Ret	Location of the flowmeter in either the feed or return line.

If High and Low alarms are installed

8.	RELO	Flw H Flw L Pwr H Pwr L Δt° H Δt° L Ft $^\circ$ H Ft $^\circ$ L Rt $^\circ$ H Rt $^\circ$ L	Defines the parameter for Relay 0 output as being high or low alarm for flow, power, temperature difference, feed or return temperatures.
9.	RELO	xxxx.xxx	Set point for parameters set in step 8 above. For low alarms the relay will close if the parameter is below the set point. For high alarms it will close if the parameter is above the set point.
10.	REL1	...	Defines the parameter for Relay 1 as in step 8 above.
11.	REL1	xxxx.xxx	Set point for parameter for Relay 1 as in step 9 above.

	<i>Parameter</i>	<i>Value</i>	<i>Description</i>
<i>If 4-20mA Output is installed</i>			
8.	4-20mA	Flow Pwr Δt° Ft° Rt°	Defines the parameter to be output as a 4-20mA signal.
9.	4mA	xxxx.xxx	Flowrate or temperature which corresponds to 4mA.
10.	20mA	xxxx.xxx	Flowrate or temperature which corresponds to 20mA.
12.	PULSE	Ener Volu	Defines whether the pulse output is for the energy or volume total.
13.	PULSE	xxx.x kWh	Defines how often a pulse is output (maximum frequency = 49Hz).
14.	COMMS	NONE M-BUS RS485	No Communications. Meter-bus (see Section 4). Modbus RTU.
15.	BAUD	xxxx	Communications baud rate between 300 and 9600.
16.	PARITY	Even/Odd/None	Communications parity.
17.	BUS	xx ADDR	Bus address for the communications link.

22 Operation

	<i>Parameter</i>	<i>Value</i>	<i>Description</i>
18.	Df DIS	YES NO	Display will revert to Energy Total if no key has been pressed for 10 seconds. Display will stay on the last displayed parameter.
19.	Fr RES	YES NO	Enable RESET key on front panel. Disable RESET key.
20.	PK/OPK	OFF ON	Indicates whether Energy will be totalised in separate Peak and Off-Peak registers. (Only displayed if mode is set to Heat, Cool or Heating/Cooling.)
21.	PK ON	xx hour	Sets the hour at which energy totalisation will commence in the PEAK register. (Only displayed if mode is set to Heat, Cool or Heating/Cooling and PK/OPK is set to ON.)
22.	PK OFF	xx hour	Sets the hour at which energy totalisation will commence in the OFF PEAK register. (Only displayed if mode is set to Heat, Cool or Heating/Cooling and PK/OPK is set to ON.)
23.	LOG	OFF MONTH WEEK DAY HOUR	Selects the interval at which Logging will take place.

	<i>Parameter</i>	<i>Value</i>	<i>Description</i>
24.	RESOL	NORM	Display Energy, Volume and Temperatures with normal resolution.
		HIGH	Display Energy, Volume and Temperatures with high resolution for testing purposes (EN1434-2). Energy and Volume will be displayed as floating point values in Joule and m ³ units respectively. Temperatures will be displayed with two decimal places.
25.	S/WARE	x.xx	Software revision number.
26.	QUIT	YES	Return to normal operation upon pressing the DISPLAY key.
		NO	Continue in the Check Set-up mode. To continue use the \triangle key to select NO and then press the DISPLAY key.

3.3 UNITS OF MEASUREMENT

The Model 212 can be programmed to operate in both metric and US units. The units which are displayed are fully programmable during the Set-up routine.

Metric

Energy	kWh	MWh	MJ	GJ
Power	kW	MW	MJ/hour	GJ/hour
Volume	litres	m ³		
Flow	l/min	m ³ /min	m ³ /hour	
Temperature	°C			

US Units

Energy	kBTU	ton x hour	therm		
Power	KBTU/min	KBTU/hour	ton	therm/min	therm/hour
Volume	gallon	ft ³			
Flow	gal/min	ft ³ /min	ft ³ /hour		
Temperature	°F				

Note: Gallons are US Gallons.

3.4 FREQUENCY CUT-OFF

A frequency cut-off can be programmed to prevent registering very low flow signals which may be the result of spurious pulses or a drift in the zero point of a flowmeter, such as magnetic flowmeter.

Input frequencies at or below the cut-off are not registered and no flow is totalised.

The relationship between the flow rate at cut-off and the frequency is:

$$\text{frequency (Hz)} = \frac{\text{flow rate} \times \text{K-factor}}{\text{time base}}$$

where time base = 60 if the flow rate is in units/min and 3600 if the flow rate is in units/hour.

flow rate = flow rate at the cut-off.

K-factor = pulses per unit for the flowmeter.

For example, if the required cut-off is 50 l/h and the K-factor for the flowmeter is 63, then the cut-off frequency:

$$f = \frac{50 \times 63}{3600}$$

$$= 0.88\text{Hz.}$$

Generally, at frequencies above 0.25Hz, the cut-off is left at the default value of 0.25Hz. However, some water meters produce relatively low frequencies and the cut-off may need to be programmed to a frequency less than 0.25Hz.

Note: Be careful when setting low cut-off values below 0.25Hz, since the display update time on the flow rate and power will become long. For example, if the cut-off is set to 0.01Hz, the instrument will continue to display the flow rate for 100 seconds, if the signal stops. This is because the time interval between the signal at 0.01Hz is 100 seconds and the Model 212 must wait this long before it can determine that the flow has actually stopped.

3.5 OFFSET FUNCTIONS

The offset function is designed for air conditioning systems with a very low Δt . Often, in these systems, a bypass valve is installed to enable any differences in the feed and return temperature to be zeroed out.

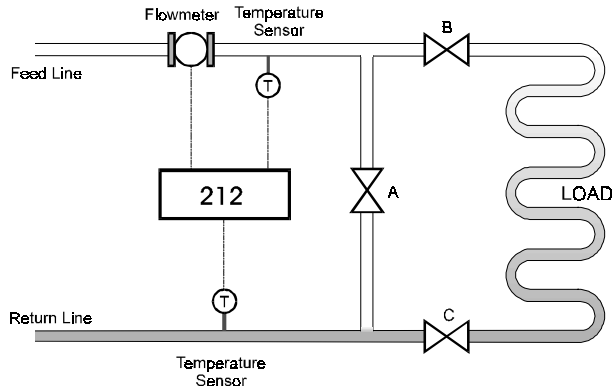

To compensate for any offset in the temperature sensors the Model 212 must be put into the Set-up Program mode. The bypass valve "A" is then opened and the valves "B" and "C" are closed.

With offset selected, the user then enters YES to zero the offset between the feed and return lines. The measured offset will then be displayed on the Model 212, the value of which will be stored when the Set-up Mode is exited.

The system is then returned to normal by closing valve "A" and opening valves "B" and "C".

3.6 OPERATING MODES

The Model 212 may be programmed to operate in either of four modes, as follows:

1. Heating
2. Cooling
3. Heating/Cooling
4. Charge/Discharge.

3.6.1 Heating

Heating mode is used when the application is for Heating only and assumes that the Feed Temperature will always be higher than the Return Temperature (positive Δt). If the Feed Temperature is lower than the Return Temperature (negative Δt), then no Energy is totalised, but Volumetric Flow is still totalised.

3.6.2 Cooling

Cooling mode is used when the application is for Cooling only and assumes that the Feed Temperature will always be lower than the Return Temperature (negative Δt). If the Feed Temperature is higher than the Return Temperature (positive Δt), then no Energy is totalised, but Volumetric Flow is still totalised.

3.6.3 Heating/Cooling

Heating/Cooling mode is used where the flow of Energy may be for Heating or Cooling. In this mode Energy is increased regardless of whether Δt is positive or negative.

28 Operation

3.6.4 Charge/Discharge

Charge/Discharge mode is used when it is necessary to maintain two Energy totals. One for when Δt is positive and one for when Δt is negative. Only one total at a time is used.

3.7 PEAK AND OFF-PEAK

When the Model 212 is programmed for either Heating, Cooling or Heating and Cooling, it is possible to program Peak and Off-Peak times. This enables the Model 212 to record Energy totals in two separate registers, depending on the time of day.

A 24 hour period can be programmed as having one peak period and one off-peak period. For example, if "PEAK ON" is programmed as 09 and "PEAK OFF" is programmed as 18, then between 9.00am and 6.00pm totalisation would occur in the **Peak** register and between 6.00pm and 9.00am, totalisation would occur in the **Off-Peak** register.

30 Operation

3.8 LOGGING

The Model 212 has the facility to log the current Energy total at fixed intervals which can be programmed to hour, day, week or month.

HOUR	A log entry will occur at 00 minutes each hour.
DAY	A log entry will occur at 00 hours 00 minutes each day.
WEEK	A log entry will occur at 00 hours 00 minutes each Monday.
MONTH	A log entry will occur at 00 hours 00 minutes on the 1st of the month.

A total of 31 log entries can be stored and viewed by the Model 212.

After 31 entries have been completed, the oldest logged entry is overwritten by the newest logged entry, therefore only the 31 most current logged entries are kept.

Logging facilities are only available if the mode of operation is set to Heating, Cooling or Heating/Cooling without Peak/Off-Peak Energy registers.

4. COMMUNICATIONS

Three modes of communications are provided:

1. Meter-bus.
2. Infra-red Communications link using M-Bus protocol.
3. RS485 with Modbus RTU protocol.

Terminals 24 and 25 provide a connection for both the Meter-bus and the RS485. Links on the main board determine which interface is selected as follows:

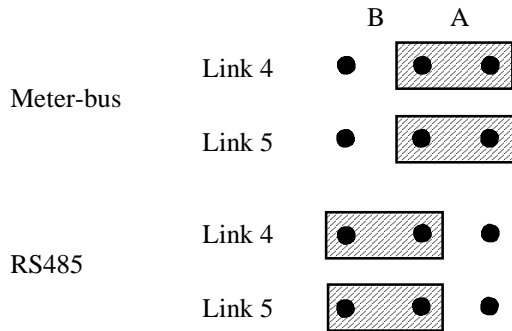

These links are accessible by removing the front panel as detailed in section 7.2 and the link positions are as shown in the drawing in section 7.3. Links are made via small black caps which fit over the connecting posts, thereby creating a link.

4.1 METER-BUS

The Model 212 serves as a secondary station in communications and includes the Meter-bus hardware and protocol according to IEC 870-5 and as detailed in EN 1434-3 with variable data format for reading out all parameters.

Hardware

The Meter-bus connection is available through galvanically isolated terminals 24/25 (irrespective of polarity) or optical interface (optional). The levels of input voltage/output current are as detailed in EN 1434-3.

Bus Address

The bus address of the Model 212 is programmable in range between 0 to 250. Some addresses are reserved according to EN 1434-3 and have a special meaning:

0	default address for unconfigured meter
251...253	reserved
254	answer regardless of own address
255	broadcast, no response.

Protocol

The protocol uses asynchronous serial bit transmission in half-duplex mode with 1 start bit, 8 data bits, 1 even parity bit, 1 stop bit and programmable baud rate (300 to 9600 baud). Link service classes S2 (SEND/CONFIRM) and S3 (REQUEST/RESPOND) are provided utilising frame format class FT1.2 according to IEC 870-5.

This protocol incorporates a frame counter bit (FCB) which has to be toggled by primary station if the last communication was undisturbed. The Model 212 keeps a copy of the last transmitted CONFIRM or RESPOND frame in order to retransmit it if the next FCB has not been toggled.

Reception Frames*

SEND (normalise):

10 40 ADR CS 16

REQUEST (data):

10 5B/7B ADR CS 16

SEND (data):

68 LEN LEN 68 53/73 ADR 51/55 DATA... CS 16

Transmission Frames*

CONFIRM (acknowledgment of NORMALISE):

E5

CONFIRM (acknowledgment):

10 00 ADR CS 16

CONFIRM (no acknowledgment, link busy):

10 01 ADR CS 16

RESPOND (no acknowledgment, data is not available):

10 09 ADR CS 16

RESPOND (data)

68 LEN LEN 68 08 ADR 72 DATA... CS 16

* byte values are represented in the hexadecimal format.

4.2 INFRA-RED COMMUNICATIONS LINK

The infra-red communication option uses the Meter-bus protocol as defined in IEC 870-5 and as detailed in EN 1434-3.

This function is not implemented at this time.

4.3 RS485 WITH MODBUS RTU PROTOCOL

Modbus RTU is an industry standard protocol which allows the Model 212 to be easily interfaced to DCS or PLC, or to computers running supervisor software systems.

The Model 212 serves as a slave station in communications and includes the RS485 hardware and implementation of the standard protocol according to Modicon Modbus Protocol (RTU-mode) and as detailed in PI-MBUS-300 Rev F. Implementation specific details are as follows.

4.3.1 Hardware

The Modbus connection is available on terminals 24/25 and links 4 and 5 must be connected as described at the beginning of this chapter.

4.3.2 Protocol

The protocol uses asynchronous serial bit transmission in half duplex mode with 1 start bit, 8 data bits and (1 parity bit + 1 stop bit) or 2 stop bits depending on whether the parity check has been programmed to "NONE" or not. The baud rate is programmable in range from 300 to 9600 Baud. The parity check can be programmed to Even, Odd or None. Link service classes SEND/CONFIRM and REQUEST/RESPOND are provided utilising frame formats according to PI-MBUS-300.

In RTU mode, messages start with a silent interval of at least 3.5 character time. Following the last transmitted character, a similar interval of at least 3.5 character times marks the end of the message. A new message can begin after this interval. The entire message frame must be transmitted as a continuous stream. A typical message frame is shown below:

ADDRESS	FUNCTION	DATA	CRC CHECK
1 byte	1 byte	N bytes	2 bytes

36 Communications

Except for broadcast messages, when a master device sends a query to a slave device it expects a normal response. One of four possible events can occur from the master's query:

1. If the slave device receives the query without a communication error, and can handle the query normally, it returns a normal response.
2. If the slave does not receive the query due to a communication error, no response is returned. The master program has to process a timeout condition for the query.
3. If the slave receives the query, but detects a communications error (parity or CRC), no response is returned. The master program has to process a timeout condition for the query.
4. If the slave receives the query without a communication error, but cannot handle it (for example, if the request is to read a nonexistent register), the slave will return an exception response informing the master of the nature of the error.

4.3.3 Bus Address

The bus address of the Model 212 is programmable in range between 1 to 247. Some addresses are reserved according to PI-MBUS-300 and have a special meaning:

0	Broadcast, no response
247...255	Reserved

4.3.4 Function Codes

The Model 212 accepts the following function codes:

<i>Code</i>	<i>Name</i>	<i>Description</i>
03	Read data register(s)	Obtain the content of one or more 2 byte data registers.
06	Preset data register	Preset one 2 byte data register.
07	Read status register	Obtain the content of 1 byte status register.
16	Preset data register(s)	Preset one or more 2 byte data registers.

4.3.5 Exception Response

The Model 212 forms an exception response by adding 80H to the function code and using an exception code as the 1 byte data field in the returned frame. Implemented exception codes are as follows:

<i>Code</i>	<i>Name</i>	<i>Description</i>
01	Illegal function	The function code is not a legal action for the slave.
02	Illegal data address	The data address is not a legal address for the slave.
03	Illegal data value	The data value is not a legal value for the slave.

38 Communications

<i>Code</i>	<i>Name</i>	<i>Description</i>
05	Acknowledge	The slave has accepted the request and is processing it, but a long duration of time will be required to do so.
06	Slave device busy	The slave is engaged in processing a long duration program command. The master should re-transmit the message later when the slave is free.

4.3.6 List of Data Registers

The following list describes addresses and meaning of data registers for the Model 212. Engineering units programmed during setup are used for floating point values. Conventional numbering of registers often starts from 1, therefore be aware that "register 1" in this case has an "address 0" and so on.

Read and Write Registers

<i>Address</i>	<i>Name</i>	<i>Value</i>	<i>Note</i>
00	Heating mode	00 - heat 01 - cool 02 - heat/cool 03 - charge/discharge	
01	Total reset	00 - no action 01 - reset totals	
02	Flowmeter location	00 - feed line 01 - return line	

<i>Address</i>	<i>Name</i>	<i>Value</i>	<i>Note</i>
<i>If High and Low Alarms are installed:</i>			
03	Relay 0 mode	00 - flow high 01 - flow low 02 - power high 03 - power low 04 - Δt° high 05 - Δt° low 06 - feed t° high 07 - feed t° low 08 - return t° high 09 - return t° low	
04	Relay 1 mode	00 - flow high 01 - flow low 02 - power high 03 - power low 04 - Δt° high 05 - Δt° low 06 - feed t° high 07 - feed t° low 08 - return t° high 09 - return t° low	
<i>If 4-20mA Output is installed:</i>			
03	4-20mA mode	00 - flow 01 - power 02 - Δt° 03 - feed t° 04 - return t°	
05	Pulse out mode	00 - volume 01 - energy	
06	Year	00...99 (when writing)	
07	Month	01...12	
08	Day	01...31	
09	Hour	00...23	
10	Minute	00...59	

40 Communications

<i>Address</i>	<i>Name</i>	<i>Value</i>	<i>Note</i>
11	Peak mode	00 - off 01 - on	
12	Peak on setpoint	00...23	
13	Peak off setpoint	00...23	
14	Logging mode	00 - off 01 - month 02 - week 03 - day 04 - hour	
15	K-factor	0.001...999,999.9	FP
17	Cutoff frequency	0.01...0.99	FP
<i>If High and Low Alarms are installed:</i>			
19	Relay 0 setpoint	0.000...999,999.9	FP
21	Relay 1 setpoint	0.000...999,999.9	FP
<i>If 4-20mA Output is installed:</i>			
19	4mA setpoint	0.000...999,999.9	FP
21	20mA setpoint	0.000...999,999.9	FP
23	Pulse out setpoint	0.000...999,999.9	FP

Read Only Registers

<i>Address</i>	<i>Name</i>	<i>Value</i>	<i>Note</i>
25	Energy 0		FP
27	Energy 1		FP
29	Accumulated energy 0		FP
31	Accumulated energy 1		FP
33	Volume		FP
35	Accumulated volume		FP
37	Not Used		FP
39	Not Used		FP

<i>Address</i>	<i>Name</i>	<i>Value</i>	<i>Note</i>
41	Elapsed time		FP
43	Accumulated elapsed time		FP
45	Power		FP
47	Peak power		FP
49	Volume flow		FP
51	Not Used		FP
53	Flow temperature		FP
55	Return temperature		FP
57	Temperature difference		FP
59	Supply failures		
60	Exception register	00 - no failure 01 - RTD failure	
61	Logging point 1 - energy		FP
63	Logging point 1 - time (seconds) since 01.01.1996		LI
...			
...			
...			
181	Logging point 31 - energy		FP
183	Logging point 31 - time (seconds) since 01.01.1996		LI
185	K-factor unit	SI: 00 - pulse/ltr 01 - pulse/m ³ US: 00 - pulse/gallon 01 - pulse/ft ³	
186	Energy unit	SI: 00 - MJ 01 - GJ 02 - kWh 03 - MWh US: 00 - kBTU 01 - ton x hour 02 - therm	

42 Communications

<i>Address</i>	<i>Name</i>	<i>Value</i>	<i>Note</i>
187	Volume unit	SI: 00 - ltr 01 - m ³ US: 00 - gallon 01 - ft ³	
188	Power unit	SI: 00 - MJ/hour 01 - GJ/hour 02 - kW 03 - MW US: 00 - kBTU/min 01 - kBTU/hour 02 - ton 03 - therm/min 04 - therm/hour	
189	Volume flow unit	SI: 00 - ltr/min 01 - m ³ /min 02 - m ³ /hour US: 00 - gallon/min 01 - ft ³ /min 02 - ft ³ /hour	

Notes:

FP This variable is represented in IEEE-754 Floating Point 4 byte format and requires two 2 byte data registers used as Modicon's floats:

<i>IEEE-754</i>	<i>Modicon Registers</i>	
1st byte	low byte	(register X)
2nd byte	high byte	(register X)
3rd byte	low byte	(register X+1)
4th byte	high byte	(register X+1)

This means that two data registers must be read/written to obtain/preset one data value.

LI This variable is represented as a long integer in 4 byte format and requires two 2 byte data registers:

<i>Long Integer</i>	<i>Modicon Registers</i>	
1st byte (MSB)	high byte	(register X)
2nd byte	low byte	(register X)
3rd byte	high byte	(register X+1)
4th byte (LSB)	low byte	(register X+1)

This means that two data registers must be read/written to obtain/preset one data value.

5. SET-UP MODE

The Set-up Mode can only be entered by removing the lower cover strip (see Section 7). Usually this will mean breaking a seal which prevents the strip being removed without tampering.

Once the strip is removed, a small hole provides access to a pushbutton. By inserting a pen tip or similar item into the hole and pressing the pushbutton, the instrument will enter the Set-up mode whereby the parameters can be entered or changed.

The DISPLAY key is used to step through each parameter and the \triangle and \triangleright keys are used to step through and change items (digits, decimal points or units). The item which can be changed flashes. Thus the instrument can be fully programmed on-site without having to purchase a separate programmer.

If the Set-up access pushbutton is pressed while the Model 212 is in Set-up Mode, the display will return to step 1.

Set-up Mode may be exited by either moving to the last set-up item, QUIT, and selecting YES, or the DISPLAY key may be pressed and held for 5 seconds. After this time, the Model 212 will return to normal operation.

	<i>Parameter</i>	<i>Value</i>	<i>Description</i>
1.	LANG	ENGL GERM	Select language.
2.	MODE	HEAT COOL HT/CL CHAR	Selects the mode of operation between Heating, Cooling, Heating and Cooling or Charge/Discharge.
3.	RESET	NO YES	Resets totals upon exiting the Set-up Mode.

	<i>Parameter</i>	<i>Value</i>	<i>Description</i>
4.	UNITS	SI US	Metric units. US units.
5.	ENERGY		Set energy units for display.
6.	VOLUM		Set volume units for display.
7.	POWER		Set power units for display.
8.	FLOW		Set flow rate units for display.
9.	FACTOR	xxx.x p/ltr	The K-factor of the flowmeter which has been programmed. (See flowmeter manufacturers data.)
10.	CUTOFF	x.xx Hz	Low frequency cut-off of the flowmeter, expressed in Hz. The Model 212 will not register flow if the input frequency is below this value. Note that the default is 0.25Hz and it is recommended to not change this value unless the flowmeter produces very low frequencies. (See Section 3.4.)
11.	OFFSET	x.x YES	The offset between temperature sensors. (See Section 3.5).
		0.0 NO	The offset function is disabled.
12.	FM LOC	Feed Ret	Location of the flowmeter as being in either the feed or return line.

46 Set-up Mode

<i>Parameter</i>	<i>Value</i>	<i>Description</i>
------------------	--------------	--------------------

If High and Low alarms are installed.

- | | | | |
|-----|------|--|--|
| 13. | RELO | Flw H
Flw L
Pwr H
Pwr L
Δt° H
Δt° L
Ft $^\circ$ H
Ft $^\circ$ L
Rt $^\circ$ H
Rt $^\circ$ L | Defines the parameter for Relay 0 output as being high or low alarm for flow, power, temperature difference, feed or return temperatures. |
| 14. | RELO | xxxx.xxx | Set point for parameters set in step 13 above. For low alarms the relay will close if the parameter is below the set point. For high alarms it will close if the parameter is above the set point. |
| 15. | REL1 | ... | Defines the parameter for Relay 1 as in step 13 above. |
| 16. | REL1 | xxxx.xxx | Set point for parameter for Relay 1 as in step 14 above. |

If 4-20mA Output is installed.

- | | | | |
|----|--------|---|--|
| 13 | 4-20mA | Flow
Pwr
Δt°
Ft $^\circ$
Rt $^\circ$ | Defines the parameter to be output as a 4-20mA signal. |
| 14 | 4mA | xxxx.xxx | Flowrate or temperature which corresponds to 4mA. |

	<i>Parameter</i>	<i>Value</i>	<i>Description</i>
15.	20mA	xxxx.xxx	Flowrate or temperature which corresponds to 20mA.
17.	PULSE	Ener Volu	Defines whether the pulse output is for the energy or volume total.
18.	PULSE	xxx.x kWh	Defines how often a pulse is output (maximum frequency = 49Hz).
19.	CLOCK	xx Hour/Min	Set time in hours and minutes. Real time clock is able to run without power for two days typically.
20.	DATE	xxxx Year/Month/Day	Set date in year, month and day. Real time clock is able to run without power for two days typically.
21.	COMMS	NONE M-BUS RS485	If no communications are to be used, Set-up Mode continues at step 25. Meter-bus (see Section 4). Modbus RTU.
22.	BAUD	xxxx	Communications baud rate between 300 and 9600.
23.	PARITY	Even/Odd/None	Communications parity (with Meter-bus the parity is not changeable and is set to even parity).
24.	BUS	xx ADDR	Bus address for the communications link.

48 Set-up Mode

	<i>Parameter</i>	<i>Value</i>	<i>Description</i>
25.	Df DIS	YES	Display will revert to Energy Total if no key has been pressed for 10 seconds.
		NO	Display will stay on the last displayed parameter.
26.	Fr RES	YES	Enable RESET key on front panel.
		NO	Disable RESET key.
27.	PK/OPK	OFF	Selects whether Energy will be totalised in separate Peak and Off-Peak registers. If set to OFF, Set-up continues at step 30.
		ON	
28.	PK ON	xx hour	Sets the hour at which energy totalisation will commence in the PEAK register. (Only available if mode is set to Heat, Cool or Heating/Cooling.)
29.	PK OFF	xx hour	Sets the hour at which energy totalisation will commence in the OFF PEAK register. (Only available if mode is set to Heat, Cool or Heating/Cooling.)
30.	LOG	OFF MONTH WEEK DAY HOUR	Selects the interval at which Logging will take place. Logging is only available if the mode (step 2) is set to Heating, Cooling or Heating/Cooling and the Peak/Off-Peak (step 27) is set to OFF. If logging is not available, this step will not be displayed.

	<i>Parameter</i>	<i>Value</i>	<i>Description</i>
31.	RESOL	NORM	Display Energy, Volume and Temperatures with normal resolution.
		HIGH	Display energy, Volume and Temperatures with high resolution for testing purposes (EN1434-2). Energy and Volume will be displayed as floating point values in Joule and m ³ units respectively. Temperatures will be displayed with two decimal places.
32.	QUIT	YES	Return to normal operation upon pressing the DISPLAY key.
		NO	Continue in the Set-up mode. To continue use the  key to select NO and then press the DISPLAY key.

6. INPUT & OUTPUT CONNECTIONS

6.1 FLOWMETER INPUT

The instrument will accept frequency or pulse inputs from a wide range of flowmeters.

Examples of connection diagrams are shown on the following pages.

Note that it may be necessary to change the position of the links as shown. These links are accessible by removing the front panel as detailed in section 7.2 and the link positions are shown in the drawing in section 7.3.

Link 1	Links in an input filter for a reed switch. The maximum input frequency is approximately 500Hz with this filter.
Link 2	Link for coils (eg. turbine or paddlewheel flow sensors).
Link 3	Not connected. This position is selected if links 1 or 2 are not required.
Link 6	Selects a two wire proximity switch when in position B.
Link 7	Selects a coil input when in position B.

The links are made via small black caps which fit over the two connecting posts thereby creating the link.

The input on terminals 10 or 11 is limited to 30 volts maximum.

Note: After connecting the flowmeter, it is also necessary to program the flowmeter factor. This is supplied by the flowmeter manufacturer and represents the number of pulses per litre, m³, gallon or ft³ that the flowmeter outputs for each unit of volume. It is often referred to as the K-factor.

1. Pulse

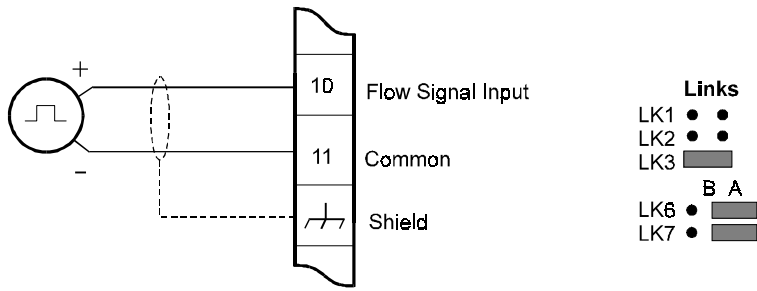

2. Reed Switch

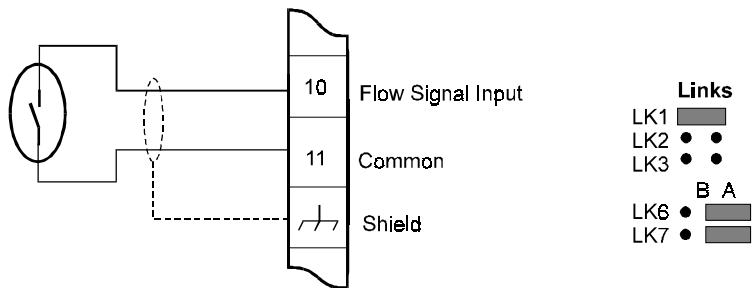

3. Coils eg. mV signals from turbine flowmeters or paddlewheels.

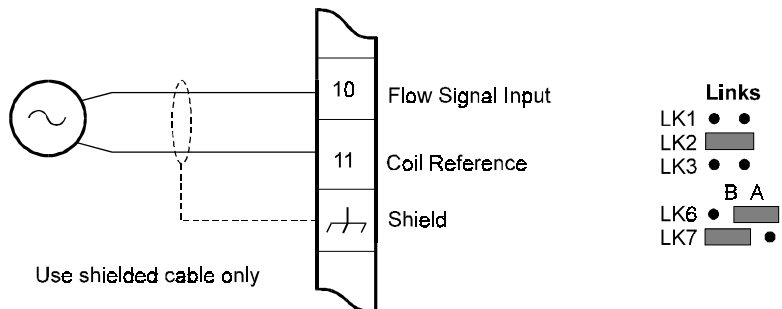

4. Opto-Sensors

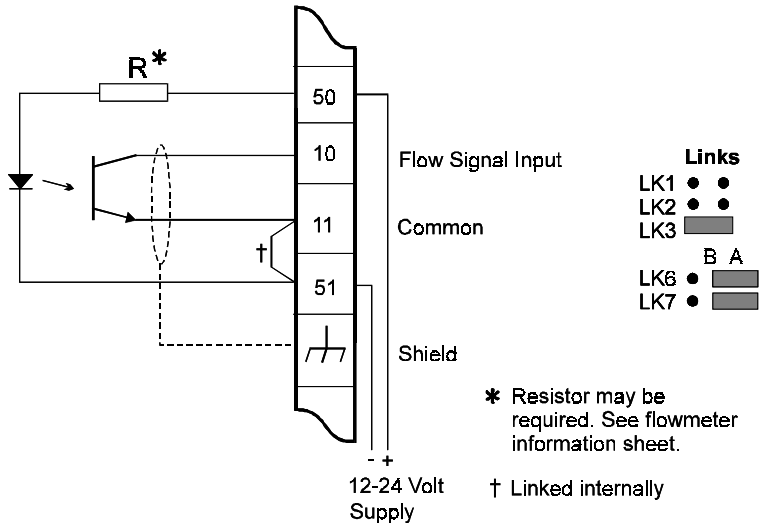

5. Namur Switch

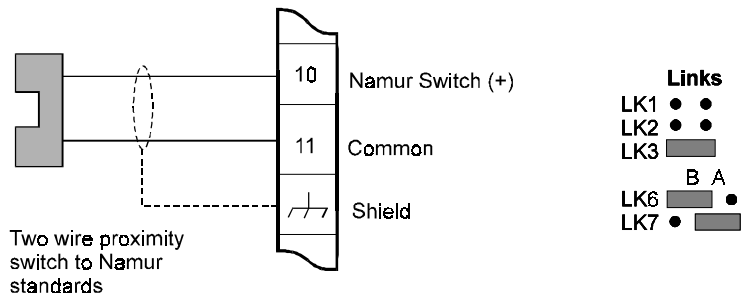

6.2 RTD INPUT

The Model 212 uses four wire RTDs to provide optimum accuracy and stability.

The RTDs are high grade 100 ohm platinum types manufactured to BS1094 standards.

It is not necessary with four wire RTDs to have equal lead lengths, but cables should not be longer than 50 meters (150 feet). They should be shielded twisted pairs connected as follows:

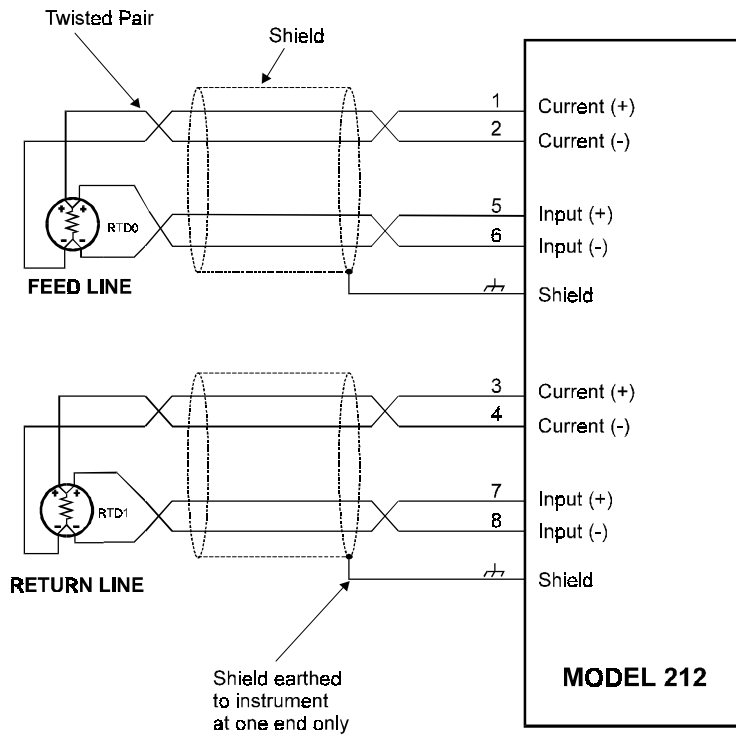

Note: Care must be taken to ensure the (+) of the current terminal is connected to the same side of the RTD as the (+) of the input terminal. The RTD, itself, has no polarity.

6.3 POWER SUPPLY

The Model 212 will operate from a central 12-24 Volts dc source and typically draws around 60mA.

A power adapter is supplied as standard and this supply can also be used to power the flowmeter, alarms and peripheral items.

The flexible power supply system allows:

1. The Model 212 to be operated from a low cost power adapter.
2. Multiple units to be powered from a single power source.
3. Mains powered systems with battery backup to be easily implemented using standard sealed lead acid batteries.

By separating the ac power from the main Model 212, the system is completely safe to install and reduces the need for qualified electricians to complete the wiring.

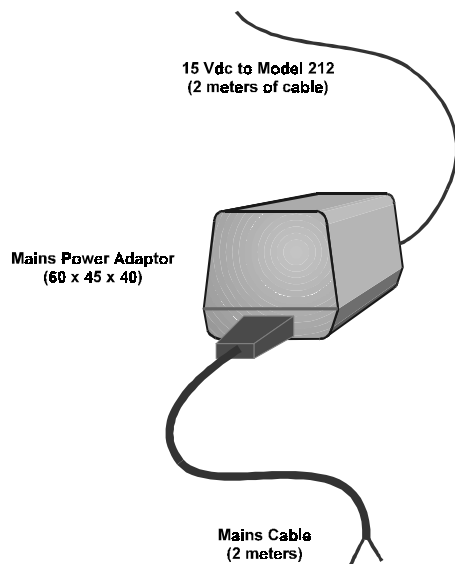

6.4 PULSE OUTPUT

A pulse output is available on terminals 16 and 17. The output is an open collector transistor suitable for external counters.

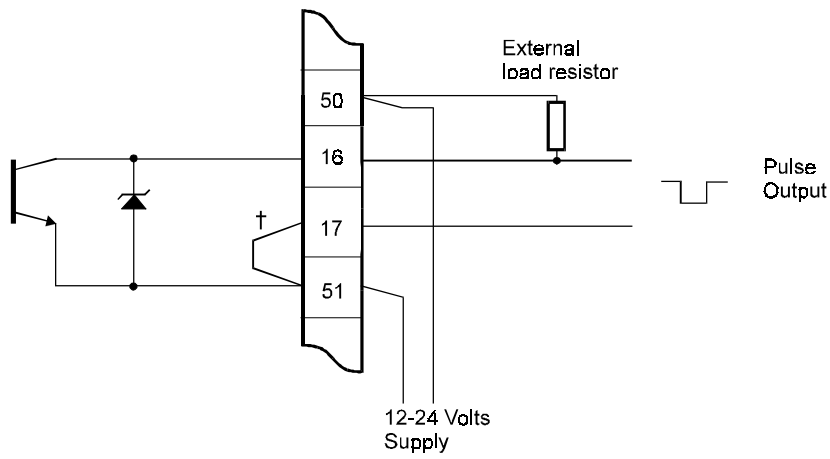
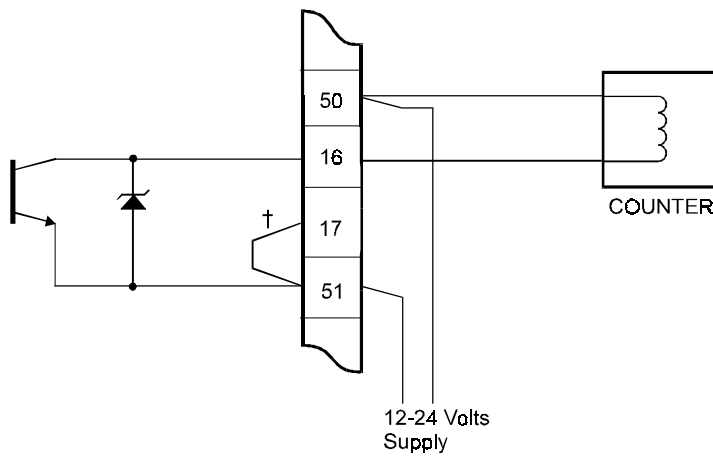

† Linked internally

56 Input & Output Connections

The output on terminal 16 is capable of sinking up to 100mA maximum and can withstand external voltages of 30 Volts. Reverse polarity and inductive load protection is provided.

Two connection examples are provided. If a voltage pulse output is required, an external load resistor must be used as shown on the second diagram.

The pulse output can be programmed during Set-up as an energy or volumetric flow output. The pulse rate is also programmable, so that a pulse can, for example, be programmed to occur every $.001\text{m}^3$.

Duration of the pulse is around 10ms thus the maximum pulse output frequency is 49Hz. Hence, in the above example, if the volumetric flow rate was $60\text{ m}^3/\text{hour}$, then this is equivalent to $0.0167\text{ m}^3/\text{sec}$. If a pulse occurs every 0.001 m^3 then the output frequency would be 16.7 Hz.

6.5 ALARM RELAY OUTPUTS

Note that the High/Low alarms are not available when the 4-20mA output option is installed.

Two Solid State dc relays are provided as alarm outputs. These relays are fully isolated and can be used to drive external relays, lamps, audible alarms, etc.

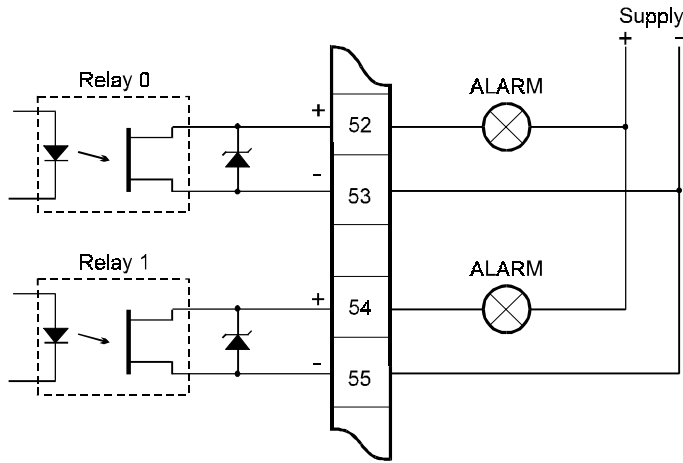

Output characteristics for Relay 0 and Relay 1 are:

Maximum Voltage	30 Volts dc
Maximum Current	250mA dc
Off State Leakage Current	5uA maximum
On State Resistance	6 ohms maximum

The relays can be individually programmed during Set-up to alarm on:

Flow rate	Low or High
Power	Low or High
Feed Temperature	Low or High
Return Temperature	Low or High
Temperature Difference	Low or High

58 Input & Output Connections

For example, Relay 0 can be programmed to alarm if the flow rate is below a certain value, while Relay 1 can be programmed to alarm if the power consumption exceeds a preset value.

In the alarm condition the relays are closed, and are open in the non-alarm condition or when the instrument is unpowered.

6.6 4-20mA OUTPUT OPTION

A 4-20mA Output Option is available and can be used to retransmit the volumetric flowrate, energy flowrate, temperature difference, feed temperature and return temperature.

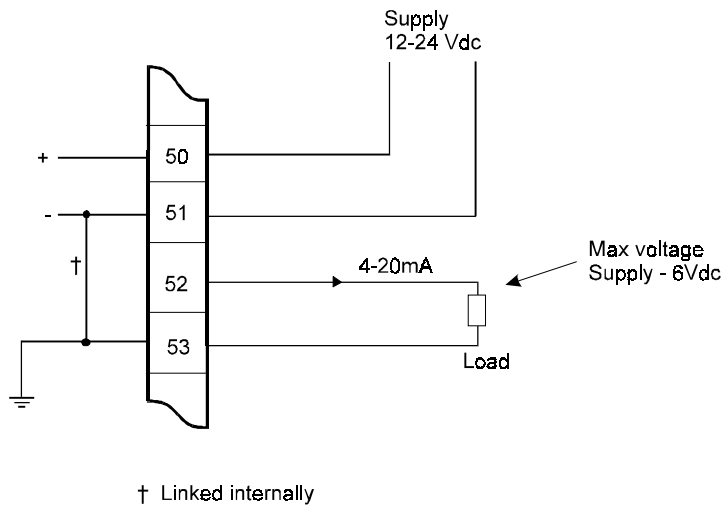

The maximum output voltage is the supply voltage less 6 volts. Therefore the maximum load resistance can be calculated as:

$$\text{Maximum Load} = \frac{\text{Supply} - 6}{0.02}$$

At 24 volts, Rmax = 900 ohms and at 12 volts, Rmax = 300 ohms.

60 Input & Output Connections

The output specifications are:

Current Range:	2.0mA to 22.0mA.
Linearity & Resolution:	0.02% of span.
Accuracy:	0.1% of span.
Response Time:	0.5 seconds to 99% of step.

The output can be programmed to output the following:

- Volumetric Flowrate
- Energy Flowrate (power)
- Feed Temperature
- Return Temperature
- Temperature Difference

The 4mA point and 20mA point can be individually programmed during setup.

7. INSTALLATION

7.1 WALL MOUNTING

A wall mounting bracket is supplied with each instrument. A drilling diagram is outlined on the following page.

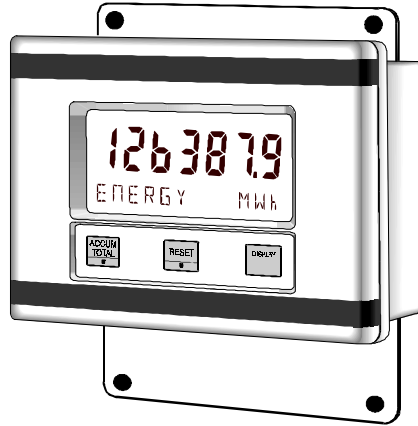

62 Input & Output Connections

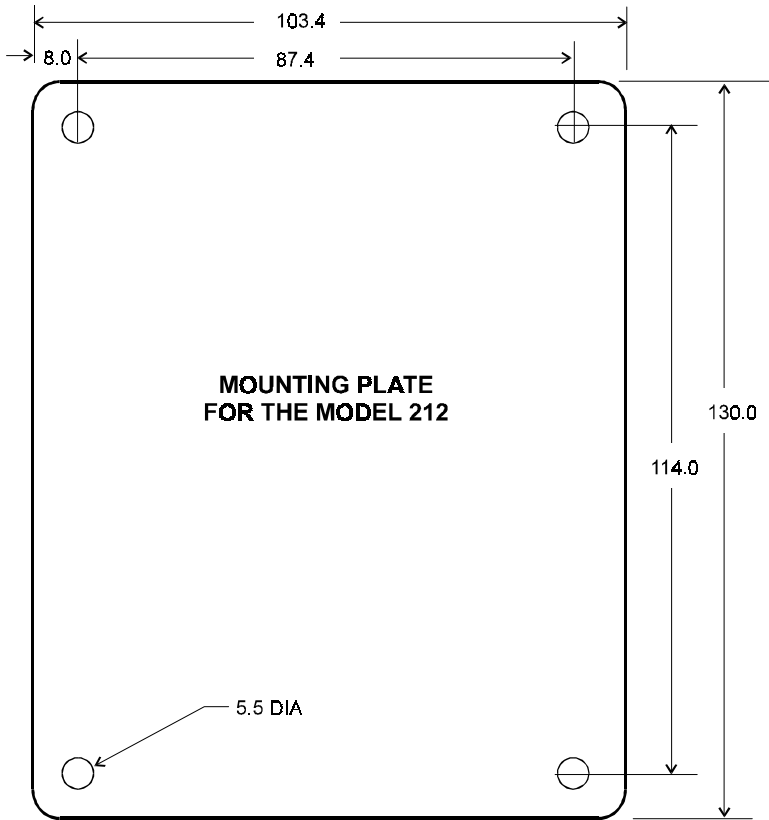

7.2 PANEL MOUNT VERSION

The panel mount version of the Model 212 is supplied with two panel mount brackets and plug-in terminals which are accessible from the rear of the instrument.

A diagram of the rear panel is shown below. Note that access to the Input Circuit Links 1-3 and Communication Links 4-7 can only be obtained by opening the instrument. Access is not available via the rear panel.

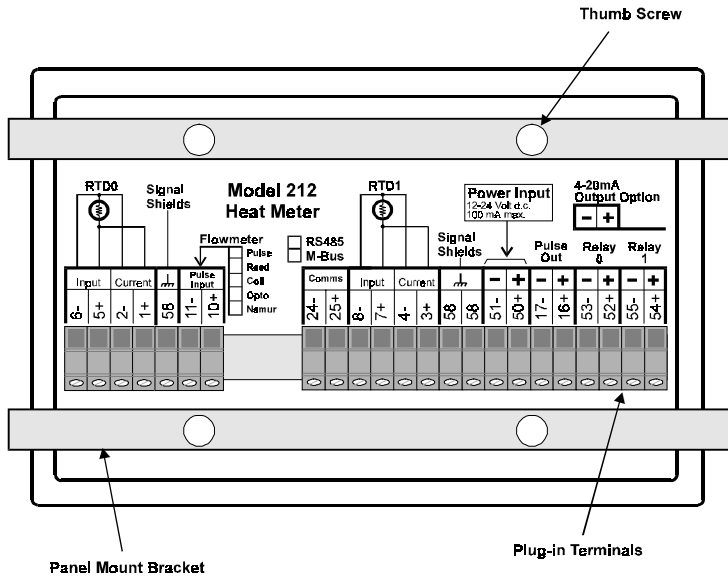

**REAR VIEW OF
212 PANEL MOUNT CASE**

The cutout for the panel mount version is 141mm (5.55") wide x 87mm (3.43") high.

7.3 REMOVING THE FRONT PANEL

The front of the instrument is removed as follows:

1. Remove both the top and bottom cover strips (ie. the dark plastic strips on the front) by using a screwdriver to lever up one end.
2. Undo the seven screws retaining the front. *Note: The screws should not be removed from the front panel as they are retained by O-rings.*
3. Pull the front panel free from the housing.

Replacing the front panel of the instrument is the reverse procedure. However, ensure that the front panel is aligned at both connector points before tightening the screws.

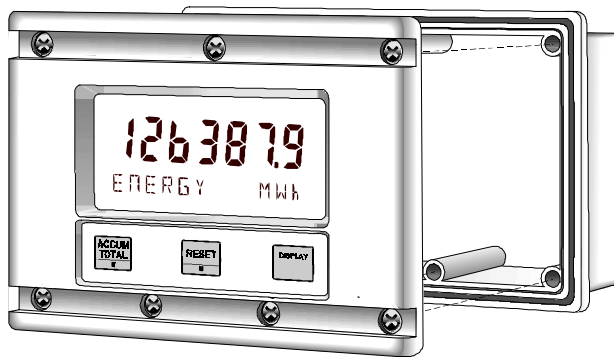
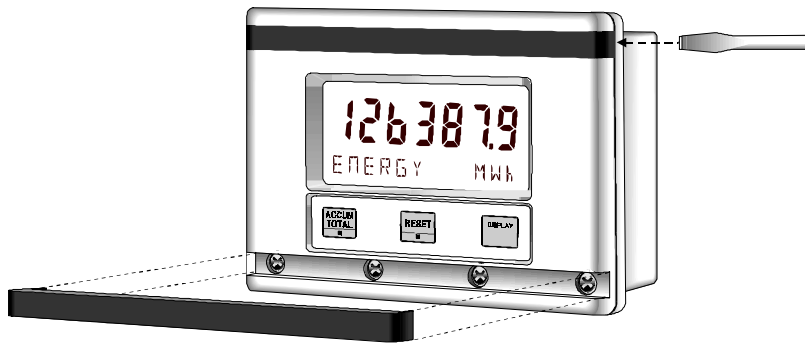

7.4 VERIFICATION SEAL

A Verification Seal is supplied with the instrument and can be placed across the calibration switch to prevent unauthorised tampering. The seal is made from a self adhesive material which is destroyed if the seal is broken.

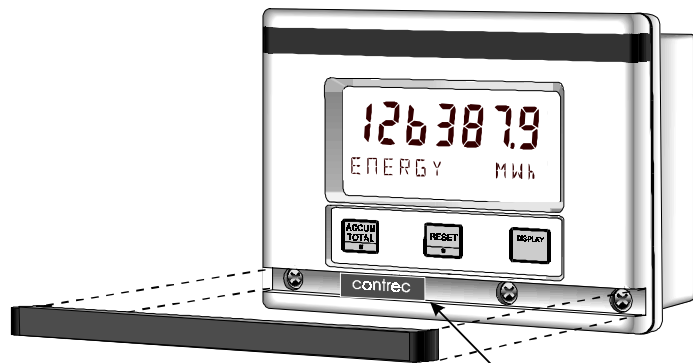

Verification Label for calibration.



7.5 WIRING PRACTICES

Three of the terminals are marked  and must be connected to a good earth, using a multi-stranded, braided wire.

It is good wiring practice to use shielded cables for all connections to the Model 212. Care must be taken to separate signal cables from power cables and relay cables, so as to minimise interference.

Overall shields should be connected at the instrument side only and to the terminals marked . These connections should be as short as possible.

In order to comply with the requirements for Electromagnetic Compatibility as per EMC Directive 89/336/EEC of the Council of the European Community, this wiring practice is mandatory.

Although it is possible to connect shields to the (-) volt supply terminal (51 -), this practice is not in accordance with the EMC Directive.

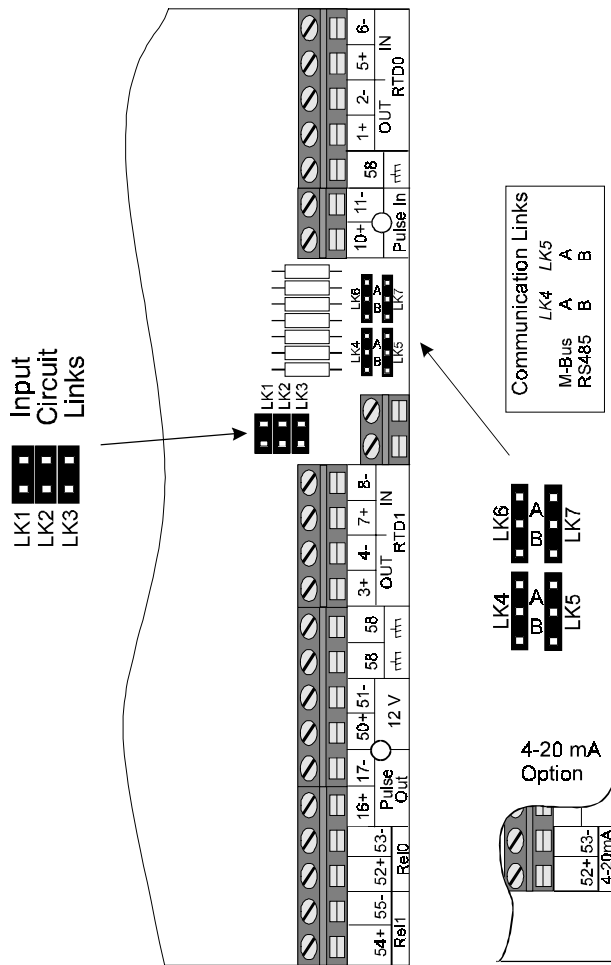

Note that on Panel Mount Versions, the connectors are mounted on the rear but the links can only be accessed by opening the enclosure

Termination Board

7.6 TERMINAL DESIGNATIONS

Terminal numbering is in accordance with international standards.

<i>Terminal</i>	<i>Description</i>	
1 +	Feed line RTD0 Current (+)	
2 -	Feed line RTD0 Current (-)	
3 +	Return line RTD1 Current (+)	
4 -	Return line RTD1 Current (-)	
5 +	Feed line RTD0 Input (+)	
6 -	Feed line RTD0 Input (-)	
7 +	Return line RTD1 Input (+)	
8 -	Return line RTD1 Input (-)	
10	Flow Signal Input	
11	Flow Signal Reference	
16 +	Pulse Output (+)	
17 -	Pulse Output (-)	
24	Meter-bus or RS485 (-)	
25	Meter-bus or RS485 (+)	
50 +	12 Volts Supply (+)	
51 -	12 Volts Supply (-)	
52 +	Relay 0 (+) dc Voltage Only	or 4-20mA (+)
53 -	Relay 0 (-) dc Voltage Only	or 4-20mA (-)
54 +	Relay 1 (+) dc Voltage Only	
55 -	Relay 1 (-) dc Voltage Only	
58 	Shields	

Index

A

ACCUM TOTAL
Key, 12
Accuracy Class, 7
Alarm Relay Outputs, 57

B

Batteries, 54
BTU, 6
Bus Address, 21
Bus Hardware, 21

C

Cable Length, 8
Charge/Discharge, 28
Check Set-up
Parameters, 19
Coils, 51
Communications, 31
Connections, 50
Construction, 9
Conversion Factors, 6
Cooling, 27
Cover Strips, 64
Cut-off, 25

D

DISPLAY Key, 12
Display Mode, 11

E

EMC, 4
EMC Directive, 67

Emission, 4
EN1434, 3
Energy
Measured, 13, 17, 18
Enthalpy, 3

F

Flowmeter Input, 50
Frequency
Cut-off, 19, 25

H

Heating, 27
Heating/Cooling
Mode, 27
High Alarms, 20

I

IEC 870-5, 32
IEC751, 7
Infra-red
Communication, 34
Input Connections, 50
Installation, 61

K

K-factor, 19
K-factor Range, 8
kBTU, 6
Key Switches, 12

L

Language, 19
Lead Lengths, 53
Links, 50
Location, 20
Logging, 30

Low Alarms, 20

M

M-bus
(refer Meter-bus), 32
Mains Powered, 54
Meter-bus, 32
Metric, 19
Modbus RTU, 35
Model Number, 5
Mounting, 61

N

Namur Switch, 52

O

Off-Peak and Peak, 29
Offset Function, 20, 26
OIML, 3
Operating Modes, 27
Operating Time, 15
Operation, 11
Opto-Sensors, 52
Output Connections, 50

P

Panel Mount, 63
Parity, 21
Peak and Off-Peak, 29
Peak Power, 14
Platinum, 53
Power, 3
Power Adapter, 54
Power Requirements, 8
Power Supply, 54
Pressures, 3
Protocol, 32
Pulse Inputs, 50

Pulse Output, 21, 55

R

Reed Switch, 51
Relay, 20
Relays, 57
RESET Key, 12
Reverse Polarity, 56
RS485, 35
RTD Input, 53

S

Sensor Type, 8
Set-up Mode, 44
Set point, 20
Shielded Cables, 67
Shields, 67
Software Revision, 23
Solid State dc Relays, 57
Specification, 7

T

Temperature
 Difference, 7
Temperature Range, 7
Terminal
 Designations, 69
Termination Board, 68
Ton, 6

U

Units of
 Measurement, 24

V

Verification Seal, 66

W

Wall Mounting, 61
Wiring Practices, 67

Z

Zero, 26