

---

# User's Manual

## Model PH71 Personal pH Meter

IM 12B03D01-01E

---

**vigilantplant.**<sup>®</sup>

# Preface

---

Thank you for purchasing the Model PH71 Personal pH Meter. Please read this manual thoroughly before using the meter.

The following symbol marks are used for safety precautions in this manual.

 **WARNING** : Indicates that serious injury may result, if the user fails to follow instructions.

 **CAUTION** : Indicates that minor injury to personnel, or damage to the equipment, may result if the user fails to follow instructions.

---

## **WARNING**

Do NOT use this instrument where there is a possibility of electrical shock.

Do NOT touch any part of the electrode immediately after using in very hot liquids — otherwise, you may get burned.

---

---

---

## **CAUTION**

Do not apply physical shock or excessive force to the glass sensor, or it may break.

If the meter will not be used for an extended period of time, be sure to remove the batteries. Otherwise battery leakage may occur, causing damage to or malfunction of the meter.

---

---

The contents of this manual are subject to change without prior notice.

Yokogawa Electric Corporation assumes no liability for damage, defects, or loss of the product caused by any of the following:

- Misuse by the user;
- Inappropriate or out-of-specifications use of the product;
- Use in an unsuitable environment;
- Repair or modification of this or related products by persons other than Yokogawa-authorized engineers.

**Preface**

**Liquid Crystal Display (LCD) Characters**

On the LCD alphanumeric characters are displayed as follows.

Alphabet	Display	Alphabet	Display	Numerals	Display
A	<i>A</i>	N	<i>n</i>	0	<i>0</i>
B	<i>b</i>	O	<i>o</i>	1	<i>1</i>
C	<i>c</i>	P	<i>p</i>	2	<i>2</i>
D	<i>d</i>	Q	<i>q</i>	3	<i>3</i>
E	<i>E</i>	R	<i>r</i>	4	<i>4</i>
F	<i>F</i>	S	<i>S</i>	5	<i>5</i>
G	<i>G</i>	T	<i>t</i>	6	<i>6</i>
H	<i>H</i>	U	<i>U</i>	7	<i>7</i>
I	<i>I</i>	V	<i>V</i>	8	<i>8</i>
J	<i>J</i>	W	<i>w</i>	9	<i>9</i>
K	<i>K</i>	X	<i>x</i>		
L	<i>L</i>	Y	<i>y</i>		
M	<i>M</i>	Z	<i>z</i>		

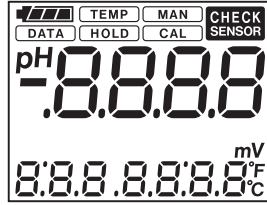

All display segments

F00.EPS

**Note Regarding Panels Shown in this Manual:**

Panels shown in this manual should be regarded as examples. Actual panel format may vary depending on parameter settings and on type of connected sensor.

**Flashing Displays**

Flashing messages, numbers and digits on the display are indicated in gray in this manual.

Flashing state: *100*

Lit state: 100

## Warranty and Service

Yokogawa products and parts are guaranteed to be free from defects in workmanship and materials under normal use and service for a period of (typically) 12 months from the date of shipment from the manufacturer.

Individual sales units may offer different warranty periods, so the original purchase order should be consulted for the conditions of sale. Damage caused by normal wear and tear, inadequate maintenance, corrosion, or due to chemical processes, is excluded from this warranty coverage.

In the event of a warranty claim, any items that are considered to be defective should be sent (freight paid) for repair or replacement (at Yokogawa discretion) to the service department of the relevant sales unit. The following information must be included in a letter accompanying the returned items:

- Model code and serial number

- Copy of original purchase order showing the date

- Length of time used, and the measuring environment

- Fault symptoms, and circumstances of failure

- Statement whether service under warranty or out-of-warranty service is requested

- Complete shipping and billing instructions for return of goods, plus the name and phone number of a contact person who can be reached for further information

Goods that have been in contact with process fluids must be decontaminated / disinfected before shipment, and a statement to this effect should be included. Safety data sheets for all process components that the goods have exposed to should also be included.

# CONTENTS

---

<b>Preface .....</b>	<b>1-1</b>
<b>1. Outline .....</b>	<b>1-1</b>
1.1 Features .....	1-1
1.2 Specifications .....	1-2
1.3 When You Receive the PH71 Meter Package .....	1-3
1.4 PH71 Meter Kit .....	1-4
1.5 PH71 Meter — Part Names and Functions .....	1-5
1.6 Sensors — Types, Part Names and Functions .....	1-6
1.7 Options (Available Separately) .....	1-7
1.8 Spare Parts .....	1-8
<b>2. Preparation .....</b>	<b>2-1</b>
2.1 Installing the Batteries .....	2-1
2.2 Connecting the Sensor Cable .....	2-2
2.3 Setting the Date and Time .....	2-3
2.4 Wetting Cap .....	2-4
2.5 Manual Temperature Setting .....	2-4
2.6 pH Calibration .....	2-5
<b>3. Measurement .....</b>	<b>3-1</b>
3.1 Precautions .....	3-1
3.2 Measurement Procedures .....	3-2
3.3 Measurement Display Panel .....	3-3
3.4 Saving a Measured Value .....	3-3
<b>4. Calibration .....</b>	<b>4-1</b>
4.1 Automatic Calibration .....	4-3
4.2 Manual Calibration .....	4-6
<b>5. Keypad and Display Functions .....</b>	<b>5-1</b>
5.1 Keypad Functions .....	5-2
5.2 Display Items .....	5-4
5.3 Function Mode .....	5-5
<b>6. Maintenance .....</b>	<b>6-1</b>
6.1 For Optimum Meter Performance .....	6-1
6.2 pH Electrode Cleaning .....	6-2
6.3 Sensor Replacement .....	6-3
6.4 Rehydrating the Glass Electrode .....	6-3
6.5 Replenishing the Electrode with Filling Solution (KCl solution) .....	6-4
6.6 Cleaning and Drying Connectors .....	6-5
6.7 Storage and O-ring/Gasket Replacement .....	6-6
<b>7. Troubleshooting .....</b>	<b>7-1</b>
7.1 Causes of Abnormal Readings and Errors .....	7-1
7.2 Error Messages, Possible Causes, and Corrective Actions .....	7-2
7.3 Causes of Abnormal Measured Values .....	7-5
7.4 Other Conditions .....	7-6
<b>8. Technical Information .....</b>	<b>8-1</b>
8.1 Measurement Principle of pH Meter (Glass Electrode Method) .....	8-1
8.2 Relationship between EMF of Glass Membrane and pH Value .....	8-2
8.3 Temperature Compensation .....	8-4
8.4 The Asymmetry Potential .....	8-5
8.5 The Alkaline Error .....	8-6
8.6 The Acid Error .....	8-7
8.7 Calibration Calculation .....	8-8
8.8 Wetted Part Materials of Sensors .....	8-9

8.9 References ..... 8-9

**Appendix ..... 1**

**MSDS (Material Safety Data Sheet) ..... MADS-1**

**Revision Record ..... i**

## Contents

# 1. Outline

---

The Model PH71 Personal pH Meter is a highly accurate, portable pH meter for laboratory and field application. With its self-diagnostic function, the PH71 provides precise measurement of pH. Measurement results can be stored and stored data can be checked on the meter display any time. The PH71 meter is of waterproof construction so that it can safely be used outdoors on a rainy day, and can also withstand being accidentally dropped into water.

## 1.1 Features

### **Water resistant case**

When this meter is used with its dedicated sensor, it meets the requirements of class IP67 according to “Degree of Protection Provided by Enclosure” in IEC 60529.

### **Simple calibration**

Automatic calibration based on preprogrammed data of standard solutions or manual calibration can be done through simple key operations.

### **Calendar and clock function**

Internal clock functions allow “one-touch checking” of measurement date and time.

### **Data storage function**

Up to 300 measured pH values along with their respective solution temperatures, dates and times, can be stored and stored data can be checked on the display any time.

### **Auto power off function**

The meter will turn off power automatically if not operated during a preset time period. The auto power off time can be user configurable in the range of 1 to 120 minutes in increments of 1 minute. The auto power off function can be disabled, where the meter should be used with care to conserve the batteries.

### **Alarm clock function**

The meter can issue an alarm signal at a specified time. Even when meter power is turned off, the internal clock can issue an alarm signal.

### **Self-diagnostic function**

A relevant error message will appear based on the self-diagnostic function.

### **Large, clear LCD**

A measured pH value, solution temperature, date and time are clearly viewed on the display.

### **Compact, lightweight, and handy**

The meter fits comfortably your hand and also stands firm on the table.

## 1. Outline

### 1.2 Specifications

Measuring range:	pH: 0 to 14 pH* <sup>1</sup> Temperature: 0 to 100°C* <sup>2</sup>
Resolution:	pH: 0.01 pH Temperature: 0.1°C
Repeatability (without sensor):	pH: ±0.01 pH ±1 digit
Accuracy (Temperature):	±0.7°C (0 to 70°C) ±1°C (above 70°C)
Temperature compensation (glass electrode emf — temperature characteristics):	Automatic compensation (or manual compensation* <sup>1</sup> )
Solution temperature:	0 to 80°C (or 0 to 100°C* <sup>3</sup> ) (0 to 50°C when a KCl replenish-free type sensor and its sensor cable are immersed in water)
Solution conductivity:	50 μS/cm or more
Ambient temperature:	0 to 50°C
Construction:	Protection class IP67 (IEC 60529)
Power source:	2x AA batteries (LR6) Auto power off function (time configurable: 1 to 120 minutes)
Battery life:	Approximately 600 hours* <sup>4</sup> of continuous use (battery type and operating condition dependent)
Dimensions:	Approximately 150(H) x 61(W) x 42(D) mm (not including connector part)
Weight:	Approximately 220 g (including batteries)
EMC Compliance:	
EMI (Emission):	EN 61326-1 Class B

Test Item	Frequency Range	Basic Standard
Electromagnetic radiation disturbance	30 to 1000 MHz	CISPR 16-1 and 16-2

T0101.EPS

EMS (Immunity): EN 61326-1 Table 2 (For use in industrial locations)

No.	Test Item	Test Specification	Basic Standard	Performance Criteria*
1	Electrostatic discharge	4 kV (contact) 8 kV (air)	IEC 61000-4-2	A
2	RF amplitude modulated electromagnetic field	80 to 1000 MHz, 10 V/m (unmodulated) 80% AM (1 kHz)	IEC 61000-4-3	B**
		1.4 to 2.0 GHz, 10 V/m (unmodulated) 80% AM (1 kHz)		A
		2.0 to 4.0 GHz, 3 V/m (unmodulated) 80% AM (1 kHz)		A

\* A: Normal performance within the specification limits: ±20% of the measured value.

B: Temporary degradation or less of function or performance which is self-recoverable.

\*\* Display value may be affected by strong electromagnetic field.

\*1: Display range is from -2 to 10 pH.

\*2: Display range is from -10 to 120°C.

\*3: When a needle type or test tube size pH sensor is used.

\*4: When alkaline batteries are used.

T0102.EPS

## 1.3 When You Receive the PH71 Meter Package

Confirm that you received all package components of the PH71 meter you ordered referring to the Model and Suffix Code and the item list in Section 1.4, “PH71 Meter Kit.” Carefully inspect the meter and sensor, referring to Section 1.5, “PH71 Meter — Part Names and Functions” and Section 1.6, “Sensors — Types, Part Names and Functions.” Particular attention should be taken:

- Not to lose a wetting cap attached on the sensor tip. This cap is needed for storage.
- Not to twist or pull the cable.
- Not to hit or drop the meter.
- Not to get connectors dirty.
- In handling of standard solutions and reagents. Solution bottles should be stored in a cool, dark place and tightly capped after use. Once opened, the contents of a bottle should be used early. Dispose of solutions in accordance with local regulations.

# 1. Outline

## 1.4 PH71 Meter Kit

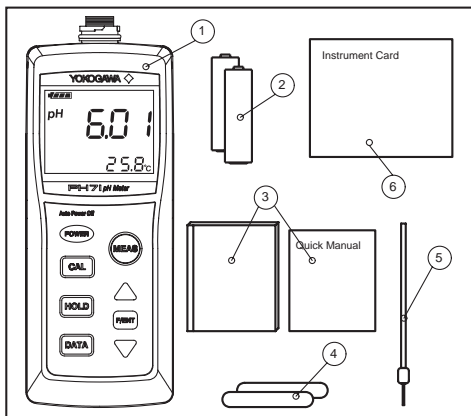

No.	Item
1	Personal pH meter
2	Dry batteries, 2x AA batteries
3	User's Manual and Quick Manual
4	Non-slip pads (2 pcs)
5	Hand strap
6	Instrument Card
7	KCl replenish-free type pH sensor
8	KCl refillable type pH sensor
9	Needle type pH sensor
10	Test tube size pH sensor
11	Cotton swabs for sensor cleaning
12	pH 4 standard solution (50 ml)
13	pH 7 standard solution (50 ml)
14	Calibration bottles (2 bottles)
15	KCl filling solution (3.3 mol/l, 50 ml)
16	Syringe (5 ml)

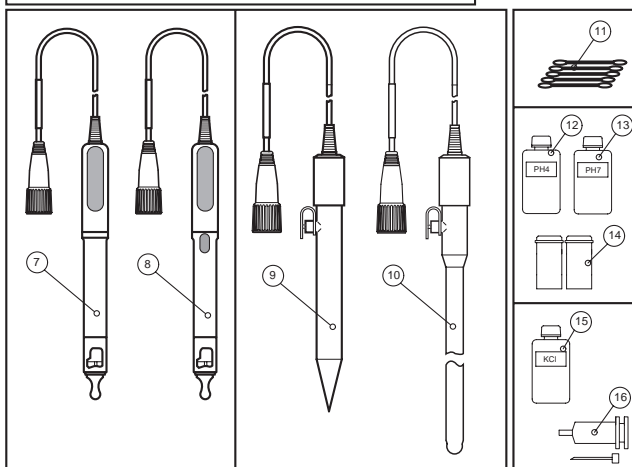

Model	Suffix Code	Specification	Items Included
PH71	-----	Personal pH/ORP meter	1 to 6 in common, plus:
Sensors	-00	Without sensor	None
	-11	With KCl replenish-free type combination pH sensor (cable length: 0.75 m)	7, 11, 12, 13, 14
	-13	With KCl replenish-free type combination pH sensor (cable length: 3 m)	7, 11, 12, 13, 14
	-21	With KCl refillable type combination pH sensor (cable length: 0.75 m)	8, 11, 12, 13, 14, 15, 16
	-23	With KCl refillable type combination pH sensor (cable length: 3 m)	8, 11, 12, 13, 14, 15, 16
	-32	With needle type pH sensor (cable length: 0.75 m)	9, 11, 12, 13, 14, 15, 16
	-33	With test tube size pH sensor (cable length: 0.75 m)	10, 11, 12, 13, 14, 15, 16
Label language	-J	Japanese	
	-E	English	
-	-AA	Always -AA	

Note: On the name plate of sensor, Model and Suffix Code of sensor itself (PH72SN-□-AA) is indicated. (See Section 1.6.)

F010401.EPS

# 1.5 PH71 Meter — Part Names and Functions

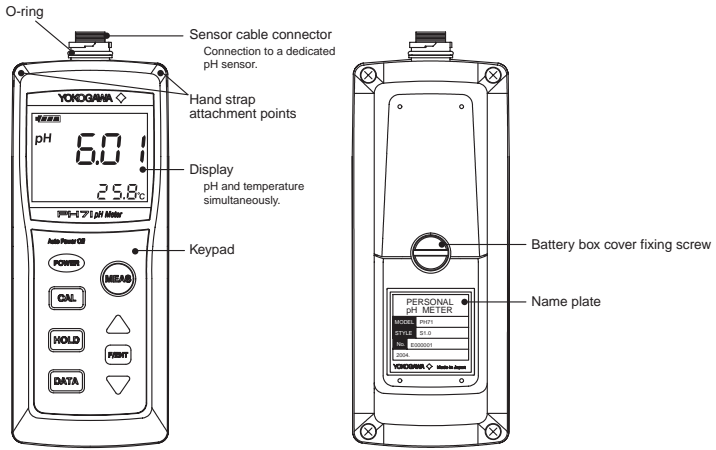

F010501.EPS

1. Outline

# 1.6 Sensors — Types, Part Names and Functions

Sensors available for use with the Model PH71 Personal pH Meter are: general-purpose pH sensors (KCl replenish-free and KCl refillable types), needle type pH sensor, and test tube size pH sensor. Check the Model and Suffix Code on the name plate to identify the type of your sensor.

Example of Name Plate

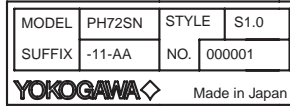

Model and Suffix Code for pH Sensors

Model	Suffix Code	Specification	Remarks*1
PH72SN	-----	pH sensor for Personal pH/ORP meter	
	-11	For PH71, PH72: KCl replenish-free type combination pH sensor (cable length: 0.75 m)	
	-13	For PH71, PH72: KCl replenish-free type combination pH sensor (cable length: 3 m)	
	-18	For PH81, PH82: KCl replenish-free type combination pH sensor (cable length: 0.75 m)*2	K9220YA
	-19	For PH81, PH82: KCl replenish-free type combination pH sensor (cable length: 3 m)*2	K9220YB
	-21	For PH71, PH72: KCl refillable type combination pH sensor (cable length: 0.75 m)	
	-23	For PH71, PH72: KCl refillable type combination pH sensor (cable length: 3 m)	
	-28	For PH81, PH82: KCl refillable type combination pH sensor (cable length: 0.75 m)*2	K9220YC
	-32	For PH71, PH72: needle type pH sensor (cable length: 0.75 m)	
	-33	For PH71, PH72: test tube size pH sensor (cable length: 0.75 m)	
	-38	For PH82: needle type pH sensor (cable length: 0.75 m) *2	K9220YG
	-39	For PH82: test tube size pH sensor (cable length: 0.75 m) *2	K9220YJ
	-AA	Always -AA	

\*1: Part number of PH81, PH82 (previous models).

\*2: Waterproofing is not guaranteed if you use PH82-type sensor in conjunction with PH71 meter.

F010601, EPS

### KCl replenish-free type combination pH sensor

### KCl refillable type combination pH sensor

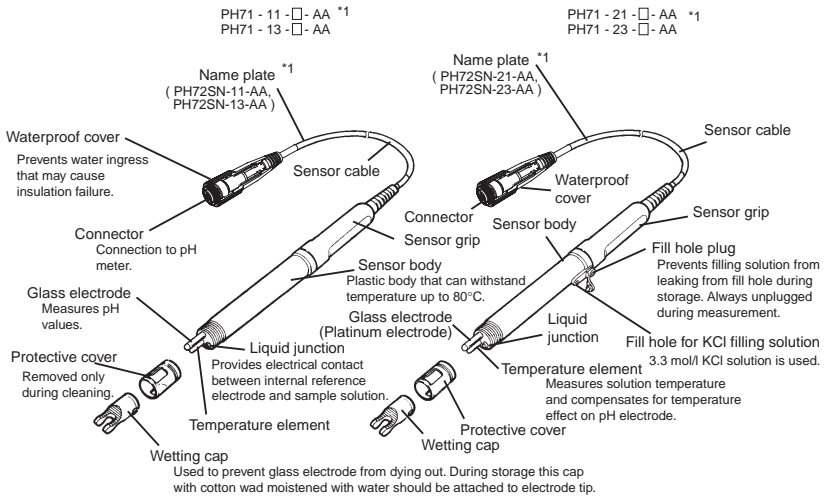

\*1: On the name plate of sensor, Model and Suffix Code of sensor itself (PH72SN-□-AA) is indicated. (See Section 1.6.)

F010602, EPS

## 1.7 Options (Available Separately)

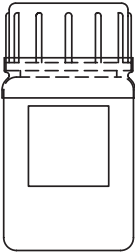
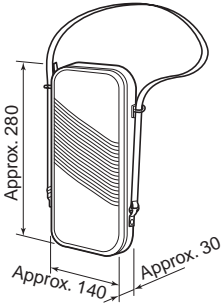
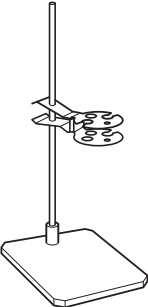

The following options are available for the Model PH71 Personal pH Meter for your convenience. When ordering, specify the part number.

pH 9 Standard solution (Part no. : K9220XF)	Soft carrying case (Part no. : B9269KJ)	Sensor stand (Part no. : K9220XN)
 <p data-bbox="187 671 437 740">Used for calibration when anticipated pH value of sample solution is alkaline. (50ml)</p>	<p data-bbox="642 316 717 336">Unit: mm</p>  <p data-bbox="463 671 721 715">A soft black carrying case holds pH meter and sensor.</p>	 <p data-bbox="738 671 988 740">Holds a sensor when pH meter is used on the table. Made of rustproof stainless steel.</p>

F010701.EPS

1. Outline

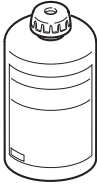
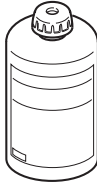
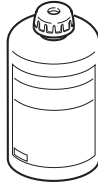
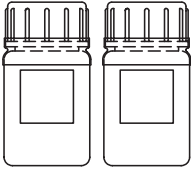
1.8 Spare Parts

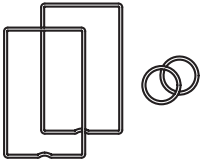
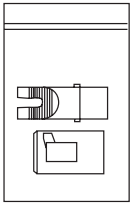
<p>pH 4 Standard solution (Part no. : K9084KF)</p>	<p>pH 7 Standard solution (Part no. : K9084KG)</p>	<p>pH 9 Standard solution (Part no. : K9084KH)</p>
 <p>Used for calibration. (250 ml)</p>	 <p>Used for calibration. (250 ml)</p>	 <p>Used for calibration. (250 ml)</p>
<p>KCl solution (Part no. : K9220XH)</p>	<p>Calibration bottle (Part no. : K9220WW)</p>	
 <p>Used to replenish KCl refillable type sensor. 3.3 mol/l, 2 bottles x 50 ml</p>	 <p>Used during calibration. 2 10-ml bottles.</p>	
<p>O-ring and gasket set (Part no. : K9654AY)</p>	<p>Cap set (Part no. : K9220ZY)</p>	
 <p>2 gaskets for battery box 2 O-rings for connector</p>	 <p>Used for sensor. 1 protective cover 1 wetting cap</p>	

F010801.EPS

## **1. Outline**

O-rings and gaskets are important parts to ensure that the PH71 meter is water resistant. Replace these parts as required. Refer to Section 6.7, “Storage and O-ring/Gasket Replacement” for replacement.

## 1. Outline

## 2. Preparation

### 2.1 Installing the Batteries

Install the batteries first.



#### CAUTION

Select a relatively moisture-free location when installing batteries in the meter.

When installing batteries, observe correct polarity (battery orientation). Failure to do so may damage the meter.

Remove batteries from the meter if it is to be stored for an extended period of time.

Do not leave dead batteries in the meter. They may leak and cause meter failure or erratic operation of the meter.

When replacing batteries, replace both batteries at the same time. If only one battery is replaced, the new battery may discharge into the old battery, which may leak chemicals and damage the meter.

If the battery box gasket is damaged or dirty then the unit may no longer be waterproof; replace the gasket in this case.

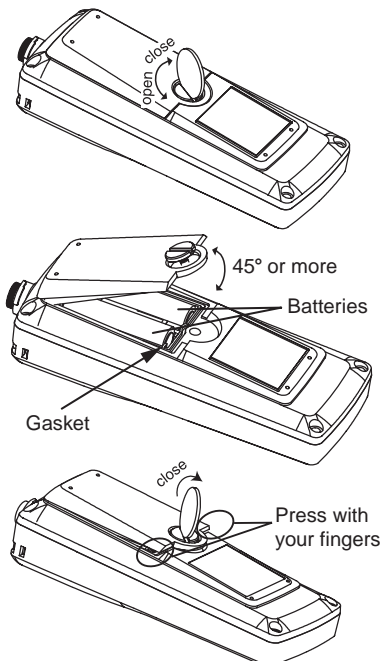

- (1) Loosen the screw holding the battery box cover using a coin or similar object.
- (2) Remove the battery box cover, and then install the batteries observing polarity diagram inside.
- (3) Make sure the gasket on the inside rim of the battery box is free of foreign material.
- (4) Put the cover back on. Insert the tabs on the top of the cover into the slots at an angle of at least 45° and lower the cover into position.
- (5) Press the both ends of the cover down with your fingers and tighten the screw to fix the cover onto the unit using a coin or similar object.  
 Note: Do not attempt to tighten further when you feel resistance before the cover is fastened in place. Loosen the screw once and retighten.

F020101.eps

## 2. Preparation

### 2.2 Connecting the Sensor Cable

Connect the sensor cable.

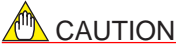

Connect the sensor cable in a place free from moisture.

When connecting the sensor cable, tighten by turning only the silver locknut, do not turn the cable or waterproof cover. Also take care not wet or contaminate the connector.

Sensors for the PH81 or PH82 meters can be connected. When used in conjunction with the PH71 meter, however, water resistance is not guaranteed. This is due to the different construction of the connector cover.

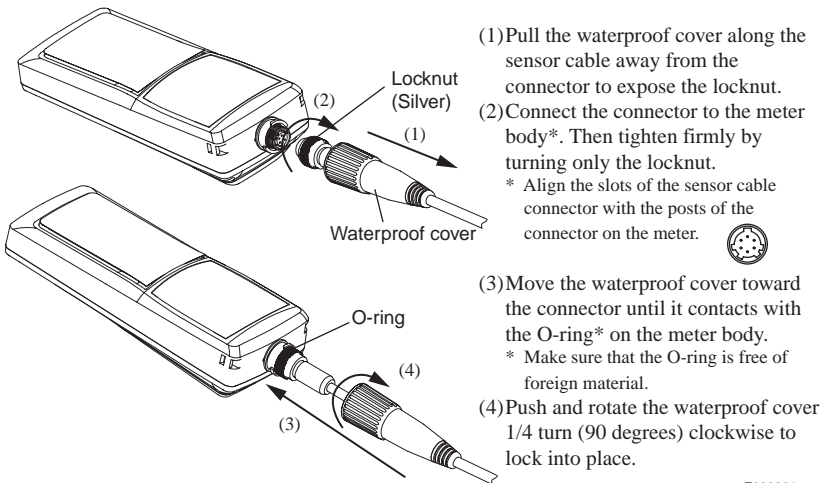

F020201.eps

Note: It is recommended that the sensor be kept connected to the meter to avoid contamination of the connectors.

## 2.3 Setting the Date and Time

After installing the batteries, set the date and time. Note that if the power is turned off before completing minute setting, start with the date setting when you turn on the power next time. By replacing the batteries, the date setting is not affected but the time setting is. So the time must be reset.

Note: If a sensor cable is not connected to the meter, fluctuating readings or an error message may appear. Before pressing **POWER** key, make sure that a sensor has been connected.

### • Setting Procedure

After installing the batteries, press and hold **POWER** key for at least one second. All LCD segments appears momentarily and then the date setting display starts automatically. Set year, month, day, hours, and minutes following the flowchart below.

Note: If you attempt to abort the setting procedure before completing, the meter will beep three times and reject the attempt. Continue until the minute setting is completed.

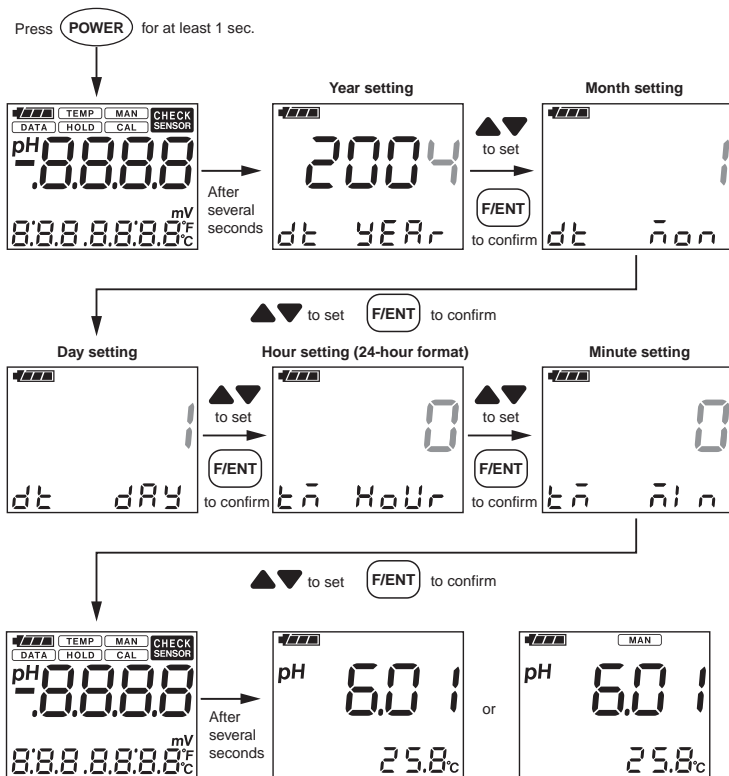

F020001.EPS

## 2. Preparation

### 2.4 Wetting Cap

The glass electrode should be kept wet during storage. If the glass electrode dries out, it will take hours to rehydrate and in the meantime the meter may give erroneous readings. The wetting cap is used to prevent the glass electrode from drying out. Sensors are shipped with a wetting cap containing a cotton wad moistened with a few drops of water. For storage replenish the cap with a few drops of water (tap water) and attach to the sensor firmly.

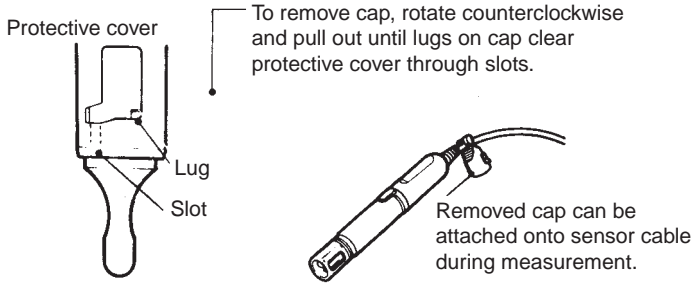

F0201.EPS

Figure 2.1 Wetting Cap

### 2.5 Manual Temperature Setting

If a sensor without a built-in temperature element (needle type or test tube size pH sensor) is connected to the meter, **MAN** mark will appear on the display. In this case, measure the temperature of the solution being measured and manually set the measured temperature into the PH71 meter for reliable measurement. The procedure is described in Section 5.3 (2), "Manual temperature setting (M.tP) panel."

Temperature compensation is performed based on a temperature shown on the display of the PH71 meter. If a temperature shown on the display is different from the actual temperature of the sample being measured, the displayed measured value may not be true. The bigger the difference between the temperature displayed on the meter and the actual temperature of the solution, the bigger the error between the displayed measured value and the true value.

If **MAN** mark appears on the display even though a sensor with a built-in temperature element is connected, refer to Section 7.4.

## 2.6 pH Calibration

The PH71 meter needs to be calibrated:

- when the sensor is connected for the first time;
- after the sensor is replaced;
- after the meter has been stored for a long period;
- after the electrode is cleaned; or
- when necessary.

The calibration procedure is described in Chapter 4, "Calibration."

Note: Calibration results are saved in the meter when the batteries are replaced.

## 2. Preparation

# 3. Measurement

## 3.1 Precautions

- (1) After storage for an extended period of time, it is recommended that the meter should be calibrated before taking measurements.
- (2) When using a KCl refillable type sensor, check the level of filling solution. (Refer to Section 6.5.)
- (3) Do not use the meter in a solution with the temperature exceeding 80°C (100°C for the needle type and test tube size pH sensors). When a KCl replenish-free type sensor is used and its sensor grip is immersed, the temperature of the solution should not exceed 50°C. Also, do not use the meter in strongly corrosive solutions, such as a solution containing hydrofluoric acid.
- (4) Remove stains from the PH71 meter body using a soft cloth or tissue. If necessary, use a neutral detergent.
- (5) If an abnormal symptom occurs during measurement, locate the cause of the problem and take corrective actions referring to Chapter 7, “Troubleshooting.”
- (6) After measurement, rinse off dirt or the sample solution from the sensor with water and store it. (Refer to Chapter 6, “Maintenance.”)
- (7) Keys should be operated by fingers.

### Using the PH71 Meter on a Table

The meter is designed as a portable instrument; however, to use it on a table, attach non-slip pads (supplied with the instrument) at top and bottom of the meter to stop it from moving when the sensor is moved.

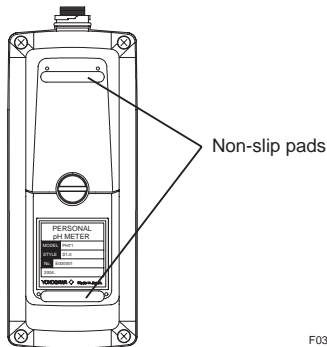

**Figure 3.1** Position of Non-slip Seats

### 3. Measurement

## 3.2 Measurement Procedures

### Immersing the sensor

Immerse the sensor so that the protective cover part goes under the sample solution level. The sensor does not need to be immersed deeply.

When using a KCl refillable type sensor, the filling solution level must be above the level of solution being measured. This is to prevent the KCl filling solution from being mixed with the sample solution.

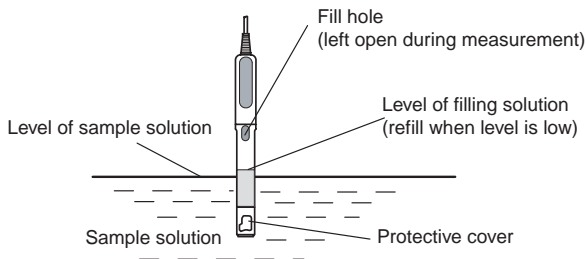

KCl refillable type sensor must be immersed so filling solution level is above the level of sample solution.

F0302.EPS

**Figure 3.2 How to Immerse the KCl Refillable Type Sensor**

Bubbles trapped in the glass electrode tip may interfere with accurate measurement. Before taking measurements, check the electrode tip for bubbles. If present, gently shake the sensor, as shown in Figure 3.3, to dislodge bubbles from the tip.

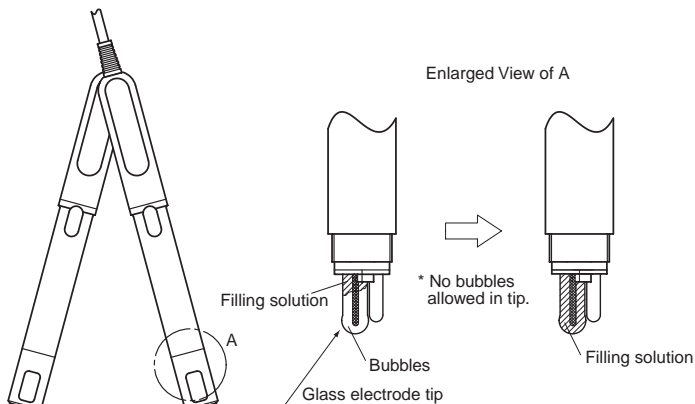

F0303.EPS

**Figure 3.3 How to Dislodge Bubbles from Glass Electrode Tip**

### 3.3 Measurement Display Panel

When immersing the sensor in a sample solution, a measured pH value will be shown on the display. There are three types of measurement display panels: the standard, calendar, and clock display panels. Use **MEAS** key to cycle through these display panels.

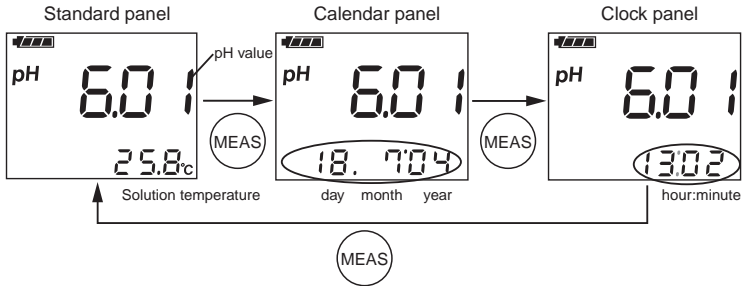

FD30301.EPS

### 3.4 Saving a Measured Value

There are two ways to save a measured value: holding temporarily and storing as a record in nonvolatile memory. Measured values stored in nonvolatile memory are not deleted even by replacing the batteries.

#### (1) HOLD

If **HOLD** key is pressed during measurement, the currently measured value is held temporarily and the displayed value no longer changes. Press **HOLD** or **MEAS** key to return to the measurement mode.

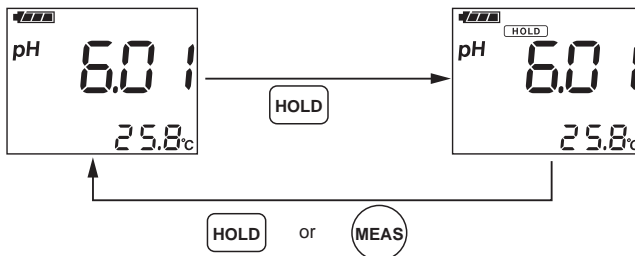

FD30401.EPS

### 3. Measurement

#### (2) Data storage

If the **DATA** key is pressed during measurement, **DATA** mark starts flashing. Press the **F/ENT** key, then currently measured data can be stored in nonvolatile memory. Data stored are measured conductivity, measured temperature, date and time. Up to 300 data including individually deleted data can be stored. If you attempt to store more data, **FULL** will be displayed.

If **FULL** is displayed before the data number has reached 300, run defrag referring to Section 5.3 (14), “Defrag memory (DFLG) panel.” This will free up memory occupied by deleted data, allowing data to be stored newly. To check stored data, refer to Section 5.3 (1), “Display stored data (dAt) panel.”

Pressing **DATA** or **MEAS** key while **DATA** mark is flashing cancels data storage and returns the meter to measurement mode.

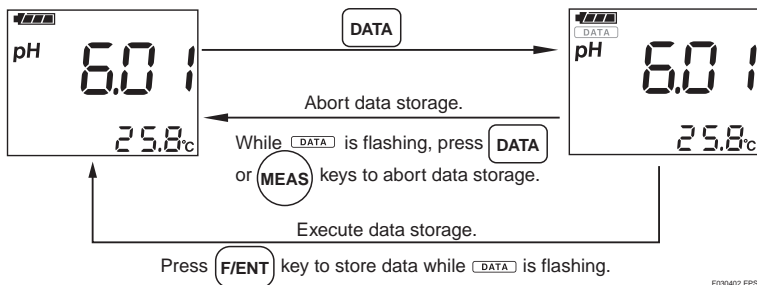

# 4. Calibration

---

Calibration using standard solutions means to measure the pH value of a certified standard solution and to adjust the pH meter so it reads the same value as the certified value of the standard solution. The PH71 meter can be calibrated automatically or manually.

The PH71 meter must be calibrated before measurement if:

- it has been stored for a long period;
- the electrode has been cleaned; or
- otherwise necessary.

## Precautions

- (1) Use certified standard solutions. Using deteriorated standard solutions will result in inaccurate calibration. Standard solutions are available as spare parts (see Section 1.8).  
Pour a portion of the standard solution into a calibration bottle (supplied) and use for calibration. Do not reuse the portion. Discard it and use a fresh portion for another calibration.
- (2) Do not press **CAL** key unless calibration is needed. Otherwise, saved calibration results may be changed.

## Before Calibration

The following should be checked and set before calibration.

### (1) Contamination of the sensor

Make sure that no dirt or deposits are present on the sensor.

### (2) Temperature setting

When using a sensor without a built-in temperature element, i.e., a needle type or test tube size pH sensor, the temperature of a standard solution to be used should be set into the meter. (Refer to Section 5.3 (2), "Manual temperature setting (M.tP) panel.")

### (3) Battery condition

Check the battery condition indicator for remaining life. If the indicator is flashing, calibration cannot be performed. Replace the batteries. (Refer to Section 2.1, "Installing the Batteries.")

#### 4. Calibration

### Error Messages during Calibration

If the meter detects an abnormality during calibration,  $\{Err 1, Err 2, Err 3\}$  or  may be displayed. In such a case take corrective actions referring to Chapter 7, “Troubleshooting.”

### Canceling Calibration

To cancel the calibration procedure, press  or  key. The meter will return to measurement mode.

### 1-point and 2-point Calibrations

There are two types of calibrations: 1-point calibration using only one standard solution and 2-point calibration using two standard solutions. One-point calibration is a simplified calibration method which can be used only when the anticipated pH values of sample solutions are near the certified pH value of a standard solution used for calibration. Two-point calibration is generally recommended.

Calibration results are not affected by turning off the power and saved until the next calibration or the initialization of calibration parameters (see Section 5.3 (10)). The last two calibration results are saved in the meter. Therefore, for 1-point calibration, first initialize calibration parameters and then perform a 1-point calibration, or without initializing, perform a 1-point calibration twice using the same standard solution.

## 4.1 Automatic Calibration

In automatic calibration the Model PH71 Personal pH Meter automatically recognizes standard solutions being used and calibrates itself using values of Table 4.1. Two types of standard solutions are preprogrammed: NIST (solutions prepared in accordance with Japanese standards, factory default) and US (solutions prepared in accordance with the U.S. standards). If NIST is selected, the meter recognizes standard solutions with pH 2, 4, 7, 9, and 12. The meter recognizes standard solutions with pH 4, 7, and 10 if US is selected.

**Table 4.1 pH-Temperature Relationship in pH Standard Solutions**

● NIST

Temperature °C Std. Solution	0	5	10	15	20	25	30	35	40	45	50	55	60	70	80
pH2	-	1.668	1.670	1.672	1.675	1.679	1.683	1.688	1.694	1.700	1.707	1.715	1.723	1.743	1.766
pH4	4.003	3.999	3.998	3.999	4.002	4.008	4.015	4.024	4.035	4.047	4.060	4.075	4.091	4.126	4.164
pH7	6.984	6.951	6.923	6.900	6.881	6.865	6.856	6.844	6.838	6.834	6.833	6.834	6.836	6.845	6.859
pH9	9.464	9.395	9.332	9.276	9.225	9.180	9.139	9.102	9.068	9.038	9.011	8.985	8.962	8.921	8.885
pH12	13.423	13.207	13.003	12.810	12.627	12.454	12.289	12.133	11.984	11.841	11.705	11.574	11.449	-	-

● US

Temperature °C Std. Solution	0	5	10	15	20	25	30	35	40	45	50	55	60
pH4	4.000	3.998	3.997	3.998	4.001	4.005	4.010	4.018	4.027	4.038	4.050	4.064	4.080
pH7	7.120	7.090	7.060	7.040	7.020	7.000	6.990	6.980	6.980	6.978	6.970	6.980	6.980
pH10	10.317	10.245	10.179	10.118	10.062	10.012	9.966	9.926	9.889	9.856	9.828	9.828	9.828

T0402.EPS

### Before Automatic Calibration

Make sure that the correct type of standard solutions to be used for automatic calibration has been selected. (Refer to Section 5.3 (9), “Standard solution setting (Std) panel.”)

#### 4. Calibration

### ● Procedure

#### Example 1: 2-point calibration using pH 7 and pH 4 standard solutions

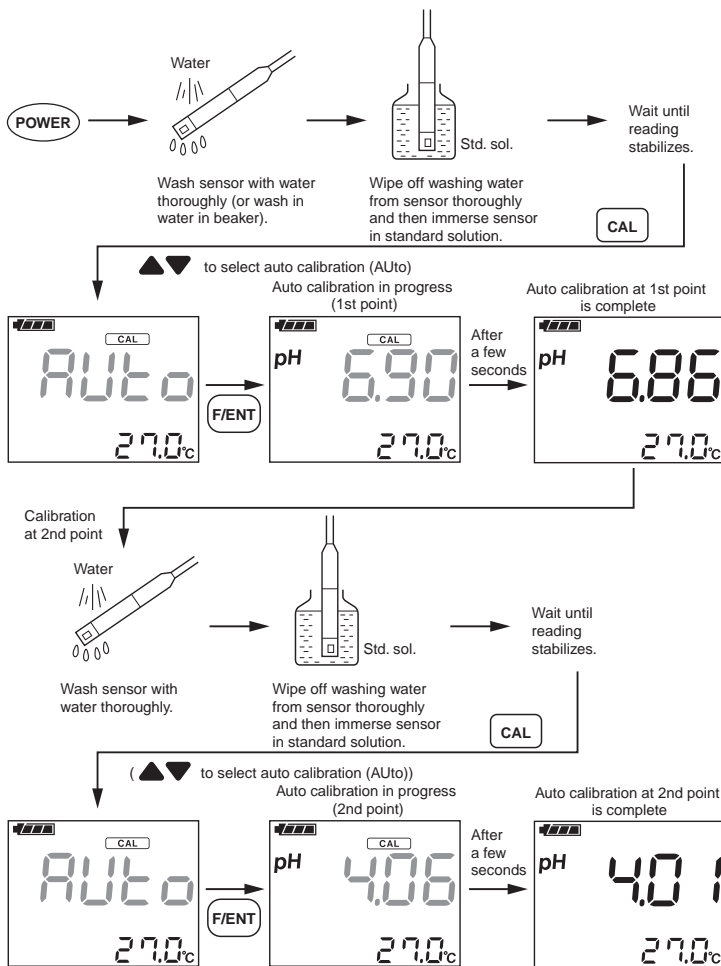

F0401.EPS

The last two calibration results are saved in the meter. Therefore, for 1-point calibration, perform a 1-point calibration twice using the same standard solution, or initialize calibration parameters (refer to Section 5.3 (10), “Initialize calibration parameters (I.CP) panel”) before performing a 1-point calibration.

**Example 2: Calibration of a sensor without a built-in temperature element\* using a pH 7 standard solution**

\* Needle type or test tube size pH sensor

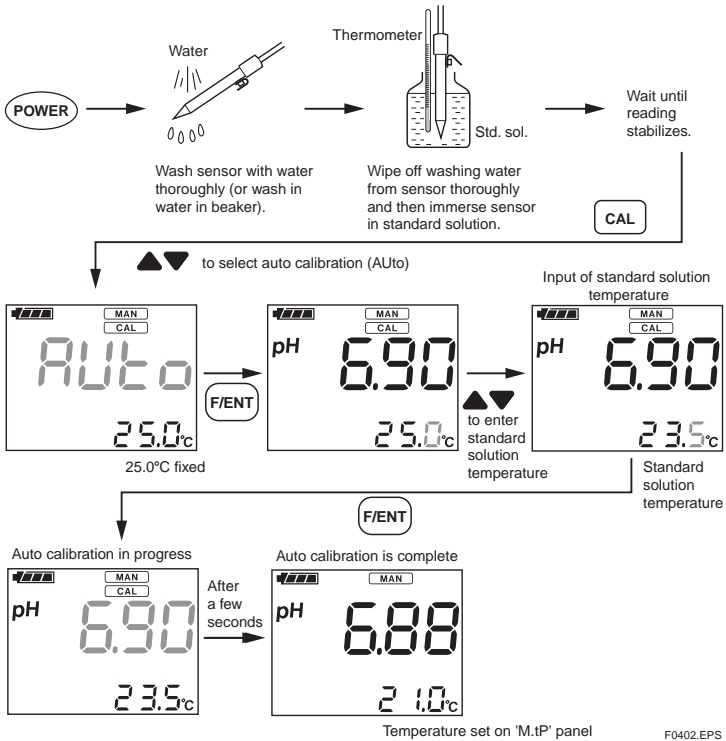

For 2-point calibration, continue the procedure in the same way as Example 1. The difference between Example 1 and 2 is that **MAN** appears on the display and the temperature of a standard solution should be entered manually.

#### 4. Calibration

## 4.2 Manual Calibration

When using standard solutions other than those preprogrammed for automatic calibration (see Section 4.1), calibration should be performed manually.

In 2-point calibration, manual calibration can be performed at both two points or manual calibration performed at one point (either 1st or 2nd) in combination with automatic calibration using a specified standard solution at the other point.

Note: Although manual calibration can be performed using standard solutions the same as the ones preprogrammed for automatic calibration, it only makes the procedure more complicated. When using these standard solutions, automatic calibration should be generally performed.

### ● Precautions

- (1) The difference between the pH values of two standard solutions to be used for 2-point calibration must be at least 0.7 pH. If not, the meter will recognize the two standard solutions as the same calibration point. That is, the second calibration result will override the first calibration value, resulting in 1-point calibration.
- (2) When using alkaline standard solutions, use the standard solution with lower pH for the first point calibration. If not,  may appear.

## ● Procedure

### Example 3: Manual calibration

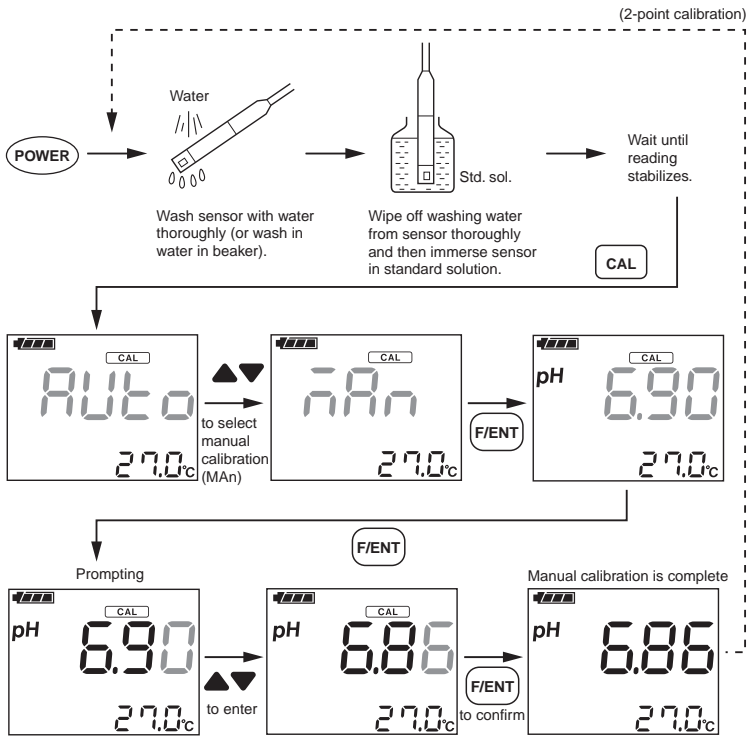

For 2-point calibration, continue the procedure following the dotted line. When using a sensor without a built-in temperature element (needle type or test tube size pH sensor), enter the temperature of standard solution following the procedure described in Section 4.1, Example 2.

#### 4. Calibration

# 5. Keypad and Display Functions

There are eight membrane keys on the keypad of the Model PH71 Personal pH Meter. The following key functions are provided.

- Displaying a pH value and temperature
- Displaying a pH value, date and time
- Holding a pH value and temperature
- Storing data — pH value and associated information
- Function mode
- Calibration

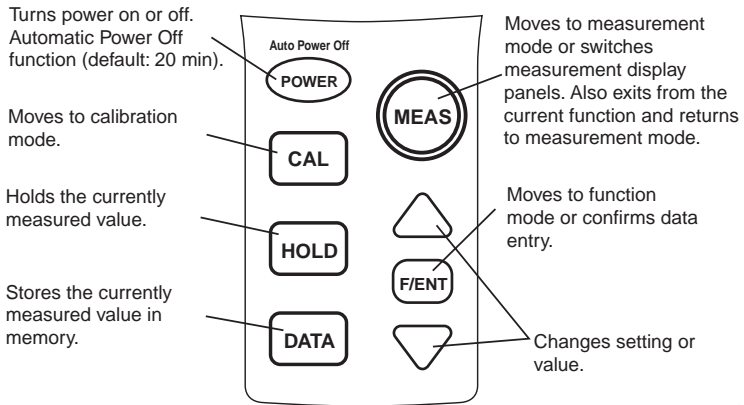

## 5.1 Keypad Functions

**POWER** : Power On/Off key

Pressing and holding this key for at least one second when nothing is displayed on the LCD, will turn the meter on. The meter will be turned off by pressing and holding this key for at least two seconds when the meter is on. If no keys are pressed for a preset time, the meter turns off power automatically. (Refer to Section 5.3 (7), "Set Auto Power Off time (A.oFF) panel.")

**CAL** : Calibration key

When pressed during measurement, **CAL** mark turns on and the meter moves to calibration mode. To return to measurement mode, press **CAL** or **MEAS** key.

**HOLD** : HOLD key

When pressed during measurement, **HOLD** mark turns on and the currently displayed measured pH value and temperature are held. Pressing **HOLD** or **MEAS** key will turn **HOLD** mark off and return the meter to measurement mode.

**DATA** : DATA key

When pressed during measurement, **DATA** mark flash and the currently displayed measured pH value and temperature are held temporarily. Pressing **F/ENT** key while **DATA** mark is flashing, will store the held data in memory. After the data is stored successfully, the meter returns to measurement mode automatically. To cancel data storage, press **DATA** or **MEAS** key while **DATA** mark is flashing. **DATA** mark will turn off and the meter will return to measurement mode.

**MEAS** : Measurement key

In measurement mode each press of this key cycles through three measurement display panels. (Refer to Section 3.3, "Measurement Display Panel.") Pressing this key in other modes will return the meter to measurement mode. If you want to cancel any operation, press this key to return to measurement mode.

**▲▼** : Setting change keys

Used to change settings.

**F/ENT** : Entry key

Pressing this key during measurement moves the display to function mode. (Refer to Section 5.3, “Function Modes.”) This key is also used to confirm data entry.

**Beep sound**

When a key is pressed, the meter acknowledges it using a beep sound.

**(1) One beep**

The meter will beep once confirming a valid key entry.

**(2) Three beeps**

The meter will beep three times if the key entry is invalid.

To disable the beep, refer to Section 5.3 (8), “Set beep on/off (bZ.o) panel.” Note that the volume of the beep sound is not adjustable.

## 5. Keypad and Display Functions

### 5.2 Display Items

Display items and their descriptions are provided below.

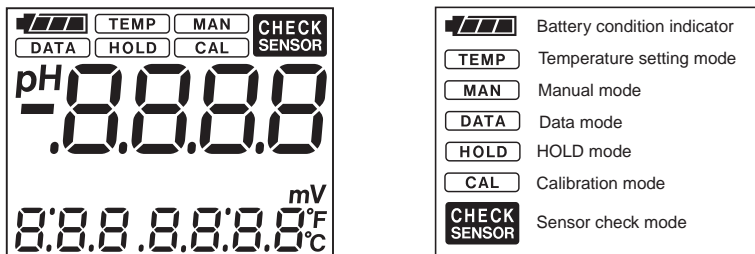

F050201.EPS

#### (1) Battery condition indicator

Indicates the level of the remaining battery life stepwise. means that there is plenty of life left. A flashing means that the batteries are low and need to be replaced immediately. When the indicator is flashing, access to calibration mode by pressing key is rejected. To replace the batteries, first press key to turn off power and make sure the display has been turned off, and then replace referring to Section 2.1, "Installing the Batteries."

#### (2) Temperature setting mode

Appears while manual temperature setting is being performed. (Refer to Section 5.3 (2), "Manual temperature setting (M.tp) panel.")

#### (3) Manual mode

Appears when a sensor without a built-in temperature element (needle type or test tube size pH sensor) is connected to the meter. (Refer to Section 2.6, "Manual temperature setting.")

#### (4) Data mode

Appears when measured data are stored or when stored data are accessed. (Refer to Section 5.1, "Keypad Functions," and Section 5.3 (1), "Display stored data (dAt) panel.")

#### (5) HOLD mode

Appears while measured data are being held temporarily. (Refer to Section 5.1, "Keypad Functions.")

#### (6) Calibration mode

Appears during calibration using standard solutions. (Refer to Chapter 4, "Calibration.")

#### (7) Sensor check mode

This mark may appear when:

- the pH electrode deteriorated significantly (check is performed during calibration);
- the standard solution used for calibration changed in quality;
- deposits are present on the electrode (check is performed during calibration).

If deposits are present, clean the sensor (see Section 6.2); or,

- calibration is performed improperly.

## 5.3 Function Mode

### Outline

Various functions are supported by function mode. Press **F/ENT** key while the meter is in measurement mode to move to function mode.

Note: The last selected and executed item is displayed when you move to function mode. Use **▲▼** keys to cycle through the items listed in Table 5.1 in that order.

### Setting Procedures

Use **▲▼** keys to move to the desired item. While the desired item is flashing, press **F/ENT** key to access that item panel. To return from function mode to measurement mode, press **MEAS** key anytime.

**Table 5.1 Function Mode Item List**

Item* <sup>1</sup>	Description	Default* <sup>2</sup>	For details, refer to:
dAt <i>dAt</i>	Display stored data	no dAtA	Item (1)
M.tP <i>M.tP</i>	Manual temperature setting	25 °C	Item (2)
dEL.A <i>dEL.A</i>	Delete all stored data	–	Item (3)
dAtE <i>dAtE</i>	Date setting	2004, 1 (month), 1 (day)	Item (4)
tIME <i>tIME</i>	Time setting	0 hour 0 minute	Item (5)
ALM <i>ALM</i>	Alarm time setting	oFF	Item (6)
A.oFF <i>A.oFF</i>	Set Auto Power Off time	20 min	Item (7)
bZ.o <i>bZ.o</i>	Set beep on/off	on	Item (8)
Std <i>Std</i>	Standard solution setting	nISt	Item (9)
I.CP <i>I.CP</i>	Initialize calibration parameters	no	Item (10)
tPU <i>tPU</i>	Set temperature unit	°C	Item (11)
VEr <i>VEr</i>	Check version number	–	Item (12)
dFLG <i>dFLG</i>	Defrag memory	–	Item (13)

\*1: For displayed digital characters, see Alphanumeric Display Table in Preface.

\*2: "–" denotes that the item is not user configurable.

T0501.EPS

## 5. Keypad and Display Functions

Operating procedures on each panel are described below.

### (1) Display stored data (dAt) panel

Shows stored data on the LCD with **DATA** mark. When you access this panel, the last stored pH value and temperature will be displayed with the data number flashing at the lower left of the display. Pressing ▲▼ keys scrolls through all stored data. If no data are stored, “no dAtA” is displayed at the bottom of the display. Each press of **DATA** key cycles through the day/month, year, and time of the stored data, and “Delete stored data” panels.

#### • Individual Deletion

By pressing **F/ENT** key when “dEL” appears underneath the value, the currently displayed stored data can be deleted. First **no** is flashing. Use ▲▼ keys to switch to flashing **YES** and then press **F/ENT** key. The stored data with the number to the left of “dEL” will be deleted.

#### • Data Numbering after Deletion

The number displayed at the bottom left indicates the stored data number relative to the beginning of the data store. This number does not necessarily represent the number of stored data. If a data item is deleted, item numbers of data that follow it will be decreased by one.

#### • Data Display after Deletion

If a data item is deleted, the data item after it is displayed. If there is no data after the deleted data item (i.e., it was the last stored data item), the data item before the deleted data item is displayed.

When data item 012 (latest data) is deleted:

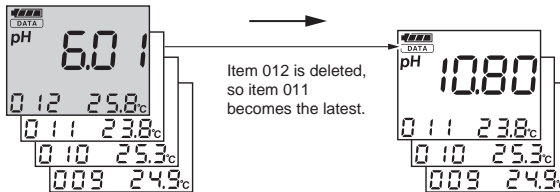

When data item 011 is deleted

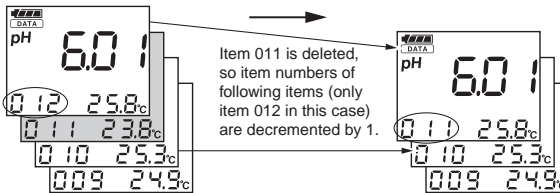

F060300.EPS

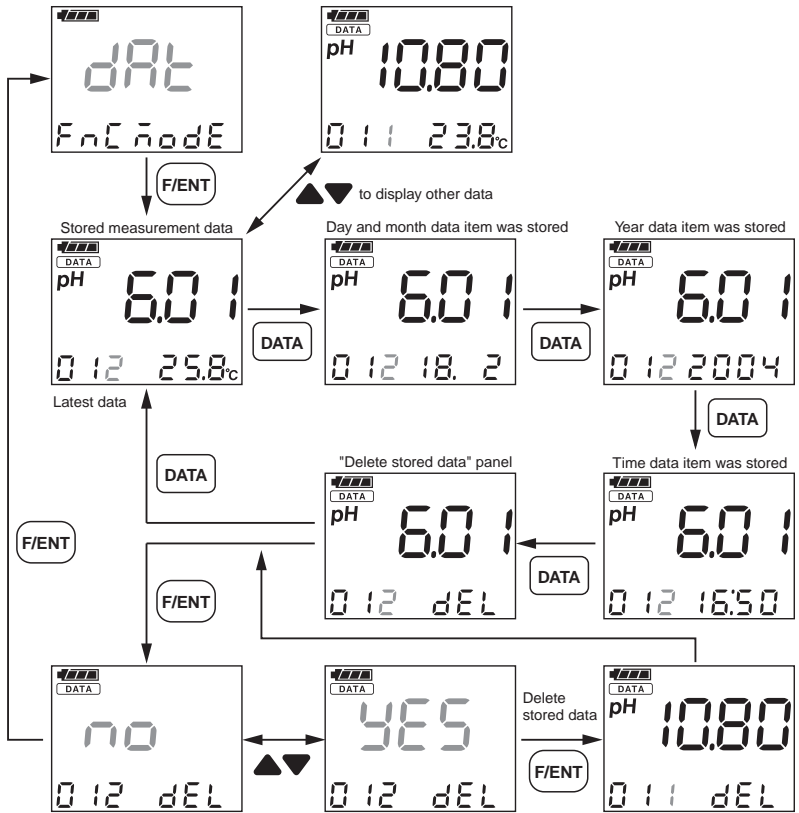

When no stored data.

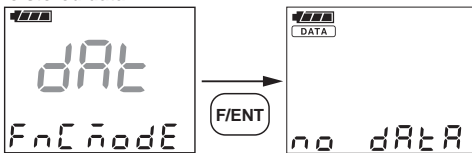

F050301.EPS

## 5. Keypad and Display Functions

### (2) Manual temperature setting (M.tP) panel

Used to input the temperature of a solution into the meter when using a sensor without a built-in temperature element (needle type or test tube size pH sensor). This setting is not required when a sensor connected has a built-in temperature element. The setting range is from -10.0 to 110.0°C.

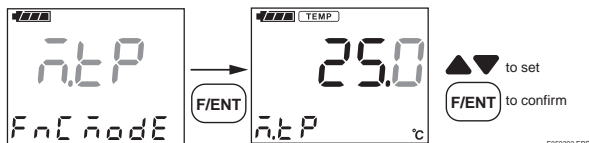

### (3) Delete all stored data (dEL.A) panel

Used to delete all stored data. Press **F/ENT** key on the flashing “dEL.A” panel. **no** will be flashing. Use **▲▼** keys to select **YES**. Press **F/ENT** key to delete all stored data completely.

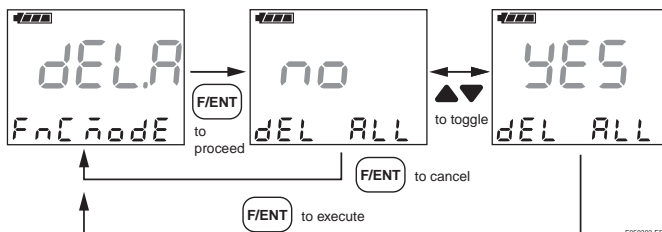

**(4) Date setting (dAtE) panel**

Used to set the year (four digits), month and day in this order. Use ▲▼ keys to set the year, month, and day, and press **F/ENT** key to confirm each entry.

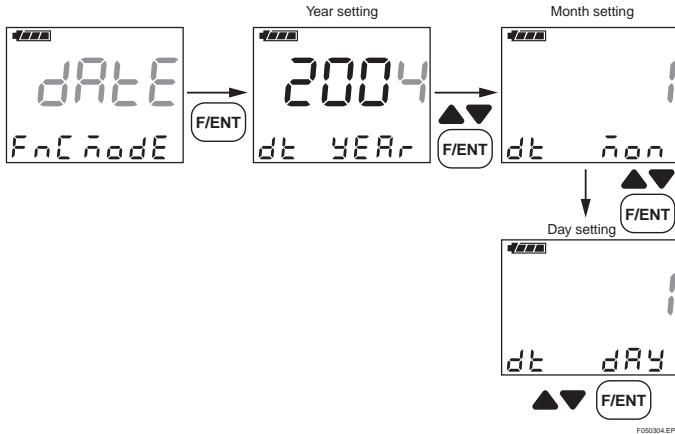

The calendar function will be valid through to year 2090.

**(5) Time setting (tIME) panel**

Used to set the time — hour (24-hour format) and minute in this order. Use ▲▼ keys to set the time and press **F/ENT** key to confirm each entry.

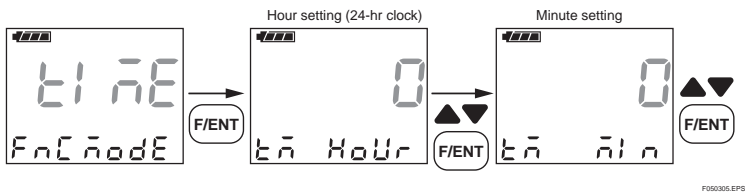

5. Keypad and Display Functions

(6) Alarm time setting (ALM) panel

Used to enable/disable the alarm clock and set the alarm clock in minutes and seconds. Use ▲▼ keys to select the desired alarm cycle: 7 days (everyday), 5 days (weekdays) or once. See Item (5), “Time setting (tIME) panel” for setting the time for alarm. The alarm sounds for about 15 seconds. Acknowledge the alarm by pressing any key. The alarm sound will stop. If no key is pressed (no acknowledgement), the alarm sounds for 15 seconds again 3 and 6 minutes after the preset alarm time. Note that the day of the week is not displayed.

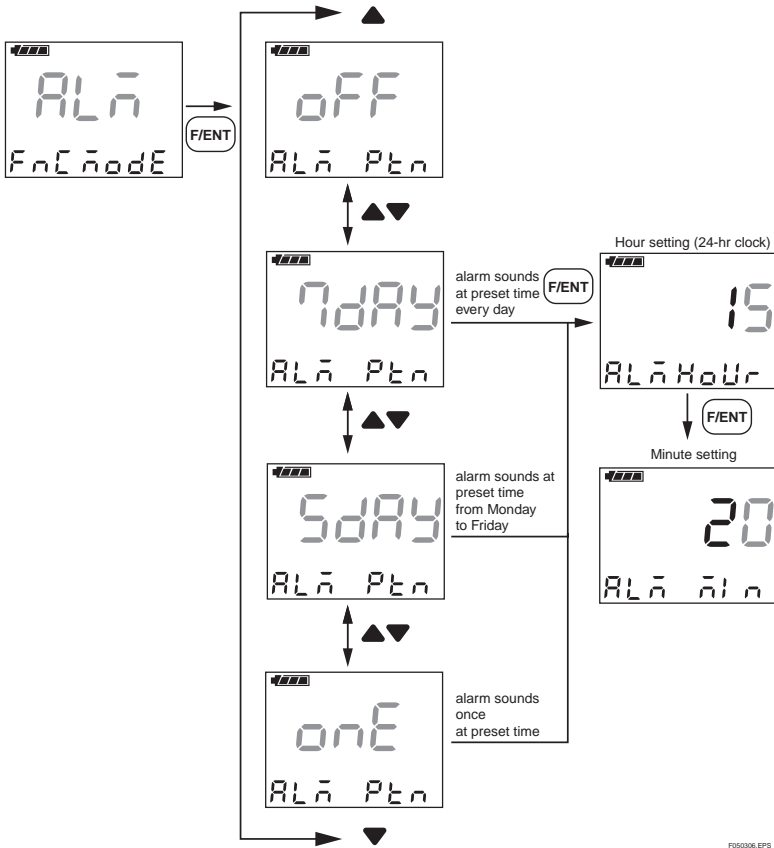

PS0306.EPS

**(7) Set Auto Power Off time (A.oFF) panel**

Used to set the automatic power off time. The meter turns off power automatically if no key is pressed during this preset time. The time range is from 1 to 120 minutes. If 0 is set, the Auto Power Off function will be disabled. Use the meter taking care to conserve the batteries.

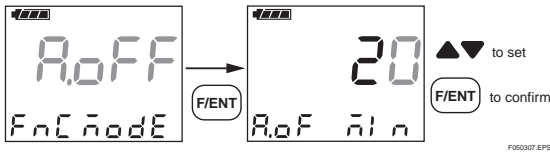

**(8) Set beep on/off (bZ.o) panel**

The beep sound on key press can be enabled/disabled in this panel. Use ▲▼ keys to select on or off and press **F/ENT** key to confirm. Note that this beep setting does not affect the alarm sounding (See Item (6)).

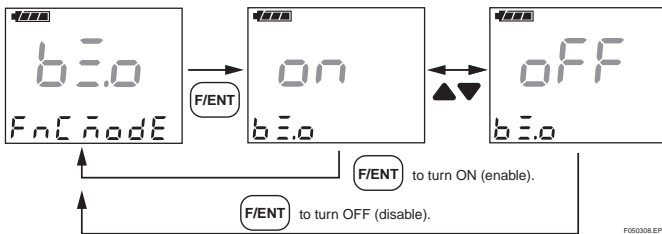

**(9) Standard solution setting (Std) panel**

Used to select the type of standard solutions: NIST or US. The factory default is NIST. When using standard solutions prepared in accordance with the Japanese standards, use the meter with the factory default of NIST. Select US only when using standard solutions prepared in accordance with the U.S. standards. (Refer to Chapter 4, “Calibration.”)

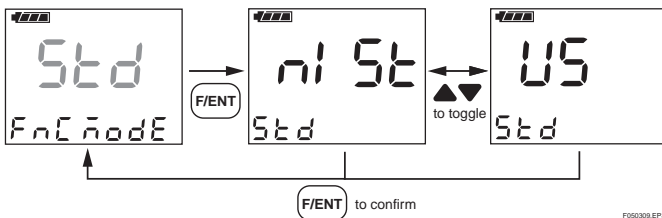

5. Keypad and Display Functions

(10) Initialize calibration parameters (I.CP) panel

Used to initialize the parameters saved by calibration to default settings: slope at 1.000 and asymmetry potential at 0.0 mV.

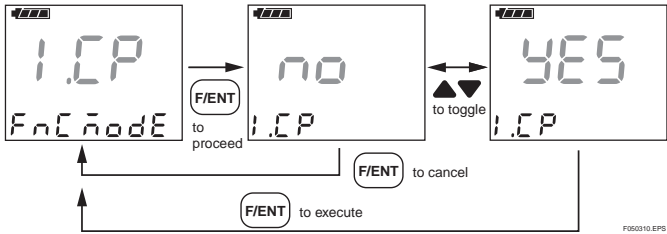

(11) Set temperature unit (tP.U) panel

Used to select the temperature unit: Celsius (°C) or Fahrenheit (°F). Use ▲▼ keys to select the desired temperature unit and press F/ENT key to confirm.

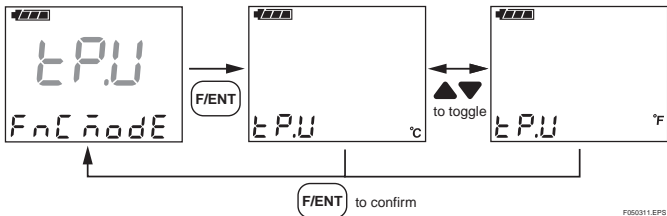

(12) Check version number (VEr) panel

Used to check the version number of the program. This is not user configurable.

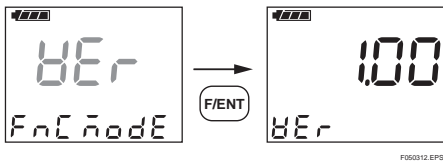

**(13) Defrag memory (dFLG) panel**

Up to 300 data can be stored. Unnecessary data can be individually deleted (refer to Item (1), “Display stored data”), but this individual deletion does not free up memory occupied by deleted data. Therefore, **FULL** may be displayed even though less than 300 data are stored. In such a case, use the defrag function to consolidate data and free up the space occupied by deleted data, thereby allowing up to 300 data to be stored.

While memory defrag is in progress, do NOT turn off the power. In addition, before starting memory defrag check that there is enough battery life left to avoid battery shutoff during memory defrag.

**• Procedure**

Press **F/ENT** key on the flashing “dFLG” display. **no** will be flashing. Use ▲▼

keys to select **YES**, then press **F/ENT** key. While defrag is in progress, “WAIT” may flash. (It may not flash depending on the amount of deleted data.) When defrag is complete, “End” appears.

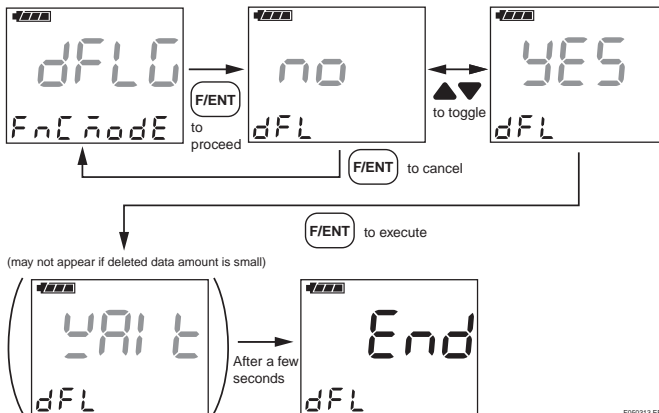

F06013.EPS

## 5. Keypad and Display Functions

# 6. Maintenance

## 6.1 For Optimum Meter Performance

The Model PH71 Personal pH Meter is simple to operate, but is a precision instrument. To ensure accurate results from the meter, the following precautions should be observed.

### Flow Diagram

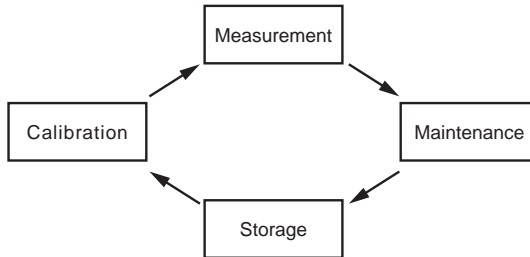

F060101.EPS

**Table 6.1 Precautions in Each Step**

Calibration	Calibration using standard solutions: <ul style="list-style-type: none"> <li>• 1- or 2-point calibration. 2-point calibration is recommended for accurate pH measurement.</li> <li>• Always use certified standard solutions (pH 2, 4, 7, 9, 10, or 12).</li> </ul>
Measurement	Sample solution requirements: <ul style="list-style-type: none"> <li>• pH range: 0 to 14 pH</li> <li>• Temperature: 0 to 80°C (0 to 100°C when using needle type or test tube size pH sensor)</li> </ul>
Maintenance	<ul style="list-style-type: none"> <li>• After measurement, rinse off remaining sample solution from the electrode thoroughly.</li> </ul>
Storage	<ul style="list-style-type: none"> <li>• Avoid a place with high temperature and humidity.</li> <li>• Keep the wetting cap (moisten the cotton wad in the cap with a few drops of water) attached to prevent the glass electrode and liquid junction from drying out.</li> </ul>

T0601.EPS

## 6. Maintenance

### 6.2 pH Electrode Cleaning

Dirt or deposits on the glass electrode or liquid junction can often interfere with accurate measurement. Periodical cleaning is required depending on the nature of the solution being measured.

#### CAUTION

---

---

Do not apply physical shock or excessive force to the glass sensor, or it may break. Do not rub the glass membrane strongly, or it may be damaged or break.

---

---

#### • **Suspended Solids, Adhesive Material, Microorganisms, Greasy Substances, etc.**

Dirt or deposits on the glass electrode, liquid junction or temperature element should be removed. Clean using a cotton swab soaked with a neutral detergent, and rinse off with water. If necessary, use a toothbrush to clean.

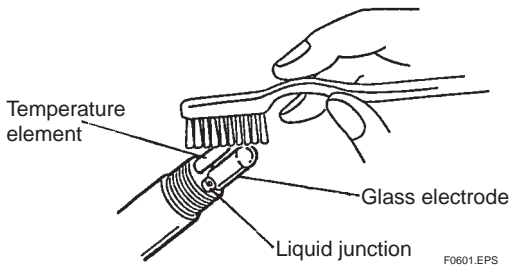
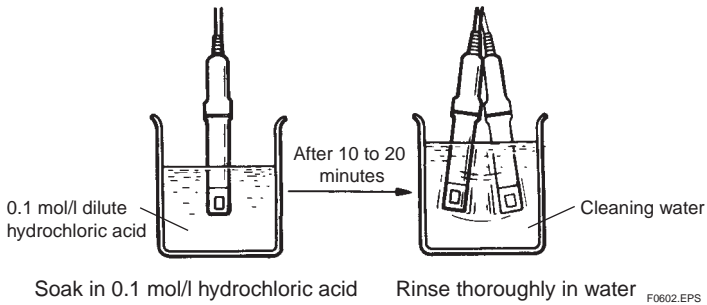

**Figure 6.1 How to Clean Using a Toothbrush**

#### • **Chemical Contaminants**

Chemical contaminants can affect the electrode performance even though the electrode appears to be clean. If **CHECK SENSOR** appears on the display, soak the electrode in dilute hydrochloric acid (approximately 0.1 mol/l, 1 to 2 pH) for 10 to 20 minutes (this process is called acid cleaning). Since an electrode deteriorates gradually in service, its performance cannot be recovered completely even if acid cleaning is conducted. After cleaning, rinse off cleaning solution from the electrode with water.

Note: Dilute hydrochloric acid is commercially available at a pharmacy. Handle with care.



**Figure 6.2 Acid Cleaning**

### 6.3 Sensor Replacement

Since a pH sensor undergoes chemical changes with time, its performance deteriorates gradually. Under normal operating conditions a sensor can be used for one or two years. Sensor deterioration, however, speeds up depending on the nature of a sample solution, e.g., a high temperature solution. Storage conditions also affect the sensor life.

If  $\text{E r r 2}$  or  $\text{E r r 3}$  appears while calibration is being performed with a sensor for which **CHECK SENSOR** is displayed, replace the sensor.

### 6.4 Rehydrating the Glass Electrode

A dry glass electrode gives fluctuating pH readings. If a glass electrode has dried up, soak it in water (tap water) for 1 to 2 hours or longer to rehydrate. The sensor will give stable pH readings.

## 6.5 Replenishing the Electrode with Filling Solution (KCl solution)

Replenishment is required only when a KCl refillable type combination sensor is used. An electrode filling solution leaks from the liquid junction little by little during measurement. When the level of filling solution drops to the level shown in Figure 6.3, replenish with a 3.3 mol/l KCl solution supplied.

 **CAUTION**

A syringe tip is sharp. Handle with care.

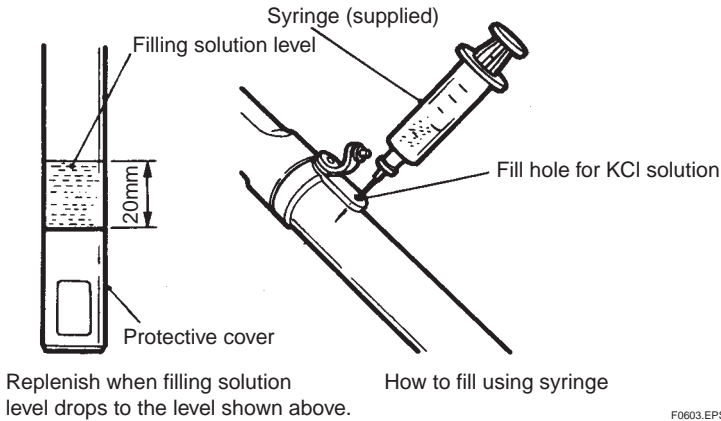

F0603.EPS

**Figure 6.3 Replenishment of Filling Solution**

## 6.6 Cleaning and Drying Connectors

Deteriorated insulation between connector pins can cause inaccurate readings. To remove stains and/or moisture that may cause deteriorated insulation, clean the connector with a dry cloth or a cloth moistened with anhydrous alcohol. If necessary, use a dryer.

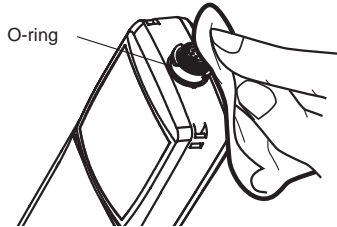

Wipe off stains and/or moisture on meter connector with a dry cloth.

Check that there are no stains on the O-ring.

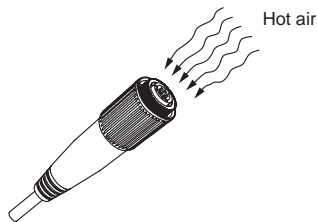

Use a dryer if necessary to remove moisture from connector of sensor cable.

F060601.eps



### CAUTION

---

Use anhydrous alcohol to clean the connectors so no moisture remains. Dry connectors completely.

---

## 6.7 Storage and O-ring/Gasket Replacement

### • Storage Precautions

Care is required when storing the meter and sensor. To maintain in good condition, observe the following:

- (1) Before storage, wash off remaining sample solution from the sensor with water. Deposits on the liquid junction, if any, must be removed thoroughly, or the junction may be clogged. A clogged junction will cause invalid measurements, e.g., unstable pH readings.  
Keep a wetting cap attached to the sensor. For KCl refillable type sensors, seal the fill hole with a plug.
- (2) Leave the sensor connected to the meter body to protect the connectors and O-ring from staining. Contamination may cause deteriorated insulation of connectors or poor water resistance by the O-ring.
- (3) Do not place any object on top of the sensor or on the top of the PH71 meter.

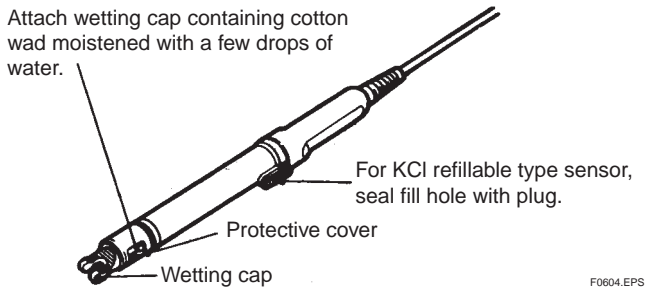

**Figure 6.4** Sensor Storage Condition

### • Storage Location

When not in use, store the meter and sensor in a safe place. If it is to be stored for a long period, store it in a place:

- With low humidity at or near normal temperatures
- Not exposed to direct sunlight or water
- No corrosive gases are present

### • Replacing the O-ring and Gasket

A gasket in the battery box and an O-ring on the sensor connector of the meter can be replaced. Heavily contaminated or damaged gasket and/or O-ring should be replaced.



### CAUTION

When installing an O-ring and gasket, clean them and their mounting surfaces with a cloth moistened with alcohol so that they are free from dirt. Otherwise, water resistance may not be assured.

**(1) Replacing the O-ring**

Install the O-ring on the cylindrical flat part of the connector, as shown below.

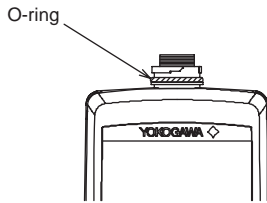

F060701.EPS

**(2) Replacing the Gasket**

Install the gasket on the groove on the battery box so the raised part fits in place as shown below. The gasket is symmetrical right to left and front to back.

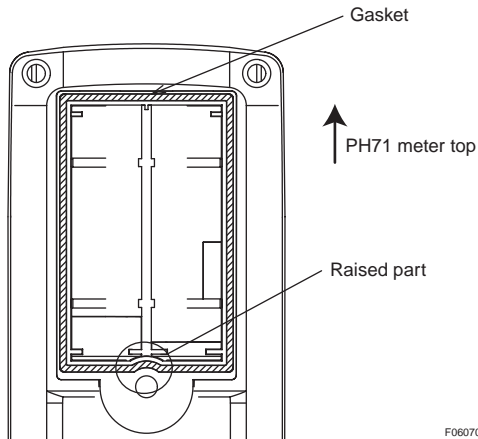

F060702.EPS

## 6. Maintenance

# 7. Troubleshooting

## 7.1 Causes of Abnormal Readings and Errors

If the pH reading is unstable or abnormal, or an error message appears, during measurement or calibration, check the following:

- (1) Improper maintenance or usage
- (2) Expired consumables
- (3) Failure



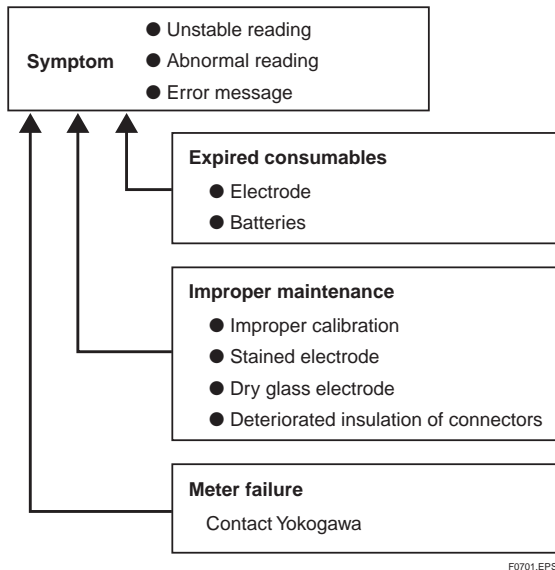



If any trouble occurs, determine the cause and take corrective actions referring to Section 7.2. If the trouble cannot be fixed, contact your nearest Yokogawa sales office.



**Figure 7.1** Causes of Abnormal Symptoms

## 7.2 Error Messages, Possible Causes, and Corrective Actions

**Table 7.1 Error Message**

Error Message*1	Description	Occurrence
Err1 	Unstable input emf	During calibration
Err2 	Abnormal asymmetry potential	
Err3 	Abnormal slope or calibration temperature	
Err4 	Out of measuring range	During measurement
Err5 	Out of temperature measuring range	
Err6 	Meter electronics failure	

\*1: For displayed digital characters, see Alphanumeric Display Table in Preface.

T0701.EPS

### (1) Err1 Unstable input emf

Appears during calibration.

A calibration result is accepted when the variation of input emf for 10 seconds falls within  $\pm 1$  mV (approximately  $\pm 0.02$  pH equivalent). If the variation for 10 seconds cannot stabilize and is outside the range of  $\pm 1$  mV even after 3 minutes has elapsed in calibration, an Err1 message will appear.

#### Possible Causes:

- Dry electrode.
- Clogged liquid junction.
- Insulation failure in electronics.
- Sensor immersed improperly.

#### Corrective Actions:

- Leave the sensor in a standard solution until the reading stabilizes, and then try recalibration.
- Remove dirt or deposits from the liquid junction. (See Section 6.2.)
- Remove stain or moisture from the connectors. (See Section 6.6.)
- Immerse the sensor properly (See Section 3.2.)
- Immerse the sensor in water for 1 to 2 hours or longer to rehydrate. (See Section 6.4.)

**(2) Err2 Abnormal asymmetry potential**

Appears during calibration.

A sensor deteriorates in service and the emf deviates from the initial one. If the difference increases and exceeds the limit that can be compensated by calibration, an Err2 message will appear. It will also appear if the pH value of the standard solution is abnormal or if the asymmetry potential is outside the range of -96 to 120 mV.

**Possible Causes:**

- Clogged liquid junction.
- Insulation failure in electronics.
- Improper standard solution.
- Dirt or deposits on electrode.
- Electrode filling solution has been depleted.
- Expired battery life.
- Electrode contaminated with standard solution.

**Corrective Actions:**

- Remove dirt or deposits from the liquid junction. (See Section 6.2.)
- Remove stain or moisture from the connectors. (See Section 6.6.)
- Use properly prepared standard solutions. (See Chapter 4)
- Perform acid cleaning. (See Section 6.2.)
- For KCl refillable type sensors, replenish with filling solution. (See Section 6.5.)
- Replace the sensor. (See Section 1.6.)
- For KCl refillable type sensors, replace the filling solution.

## 7. Troubleshooting

### (3) Err3 Abnormal slope or calibration temperature

Appears during calibration.

In the Model PH71 Personal pH Meter standard solution data (NIST and US) are preprogrammed. During automatic calibration the meter recognizes standard solutions being used based on these data. If standard solutions other than the preprogrammed ones are used, an Err3 message will appear. It will also appear if the slope is outside the range of 65 to 125%.

#### Possible Causes:

- Defective standard solutions.
- Dirty electrode.
- Clogged liquid junction.
- Insulation failure in electronics.
- Outside calibration temperature range.
- Improper manual temperature setting.

#### Corrective Actions:

- Use properly prepared standard solutions. (See Chapter 4.)
- Remove dirt or deposits from the electrode and liquid junction. (See Section 6.2.)
- Remove stain or moisture from the connectors. (See Section 6.6.)
- Perform calibration within the calibration temperature range.
- Set the temperature of the solution used manually and correctly. (See Section 5.3 (2).)

### (4) Err4 Out of measuring range

Appears during measurement.

The Model PH71 Personal pH Meter can measure the pH value of a solution in the range of 0 to 14 pH. If the pH value of the solution being measured is significantly outside this range (-2 pH or lower and 16 pH or higher), an Err4 message will appear. It will also appear if the electrode is dirty or has dried out. When a new sensor is used for the first time, an Err4 message may appear. This is due to low hydrophilic property a new sensor may have.

#### Possible Causes:

- Solution pH is significantly outside the measuring range of 0 to 14 pH.
- Dry electrode.
- Dirt or deposits on electrode.

#### Corrective Actions:

- Immerse the sensor in water for 1 to 2 hours or longer to rehydrate. (See Section 6.4.)
- Remove dirt or deposits from the sensor. (See Section 6.2.)

**(5) Err5 Out of temperature measuring range**

Appears during measurement.

With the Model PH71 Personal pH Meter, a general-purpose sensor can be used in the temperature range of 0 to 80°C and a needle type or test tube size sensor in the temperature range of 0 to 100°C. If the operating temperature is significantly outside this measuring range (below -10.0°C or above 120°C), an Err5 message will appear.

**Possible Cause:**

- Operating temperature is significantly outside the measuring range.

**Corrective Action:**

- Adjust the temperature of the solution so it falls within the measuring range (0 to 80°C for general purpose types and 0 to 100°C for needle type or test tube size sensor).

**(6) Err6 Meter electronics failure****Possible Cause:**

- Failure of electronics.

**Corrective Action:**

- Contact your nearest Yokogawa sales office.

## 7.3 Causes of Abnormal Measured Values

If error messages do not occur, but measured values seem incorrect, check the following:

- Are proper standard solutions used?
- Is the sensor connected to the meter securely?
- Are air bubbles trapped in the electrode tip?
- Has the electrode dried out?
- Is the electrode dirty?
- Is the sensor damaged or dirty?
- Is the electrode immersed in the sample solution properly?
- Has the level of the electrode filling solution dropped (for KCl refillable type sensors)?
- Is the electrode filling solution contaminated with the sample solution (for KCl refillable type sensors)?
- Has the actual temperature of the solution been set properly (for a needle type or test tube size pH sensor)?

## 7. Troubleshooting

### 7.4 Other Conditions



- **An alarm sounds**

The alarm is set to sound at the preset alarm time. Refer to Section 5.3 (6), “Alarm time setting (ALM) panel.”

- **Beeps**

The beep sound to acknowledge a key press can be enabled/disabled. Refer to Section 5.3 (8), “Set beep on/off (bZ.o) panel.”

- ** appears**

This indicates that the electrode has deteriorated. The electrode may be used continuously even after this mark appears. If a  or  message appears in addition to this mark, however, replace the sensor with a new one immediately.

This mark will also appear when deteriorated or poor quality standard solutions are used for calibration, when dirt or deposits are present on the electrode, or when calibration is performed improperly. When it appears, perform acid cleaning (see Section 6.2) and recalibrate using fresh standard solutions.

- ** appears**

This does not indicate any failure if a sensor without a built-in temperature element (a needle type or test tube size pH sensor) is used. If this mark appears, manually set the temperature of a solution. (See Section 5.3 (2).)

If it appears even though a sensor with a built-in temperature element is used, the temperature measuring circuit may have broken. In this case the meter performs temperature compensation assuming that the solution temperature is 25°C. Therefore, the bigger the difference between the actual temperature of the solution and 25°C, the bigger the error between the displayed measured value and the true value. For reliable measurement replace the sensor with a good one.

This mark will also appear if the sensor is not connected properly. Make sure that the connectors are securely connected.

## 8. Technical Information

### 8.1 Measurement Principle of pH Meter (Glass Electrode Method)

A pH meter makes use of the potential difference developed between the two sides of a thin glass membrane that separates two solutions with different pH. Figure 8.1 shows the schematic diagram of the measurement principle. A glass electrode is filled with a pH 7 solution and has an inner electrode that measures the potential difference corresponding to the pH difference between the internal solution and the test solution. A reference electrode has a constant potential irrespective of the pH of the test solution, which is supported by potassium chloride (KCl) solution. It prevents the reference electrode from making contact with the test solution but itself has electrical contact with the test solution through the liquid junction. A voltmeter measures the potential difference between the electrodes. As the membrane resistivity is high (several 10 to 100 M $\Omega$ ), the voltmeter with high input impedance is required. The external leak resistance should also be sufficiently high (10<sup>12</sup>  $\Omega$  or greater).

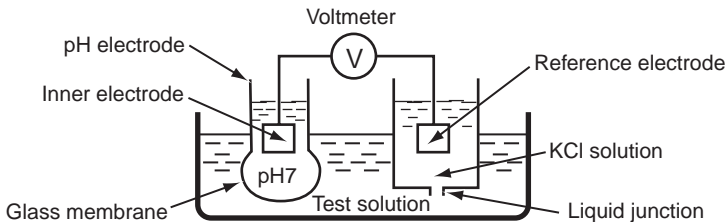

F0801.EPS

**Figure 8.1 Measurement Principle of pH Meter**

## 8.2 Relationship between EMF of Glass Membrane and pH Value

The relationship between the potential difference (electromotive force) developed across the glass membrane and the pH value had been studied and the theoretical values were determined. Actual values, however, do not match the theoretical values due to manufacturing variations or deterioration with time. Therefore, a pH meter must be calibrated using standard solutions.

The emf of a glass electrode is affected by temperature. To compensate for this temperature effect is called "temperature compensation" which is essential for pH measurement.

Figure 8.2 shows the diagram of glass electrode membrane. Both membrane surfaces in contact with solutions are hydrated and the hydrogen ion activity in these hydrated layers is constant. A boundary potential develops depending on the ratio of the hydrogen ion activities of the hydrated layer and of the solution. This boundary potential,  $e_i$ , is expressed from the Nernst equation as follows.

$$e_i = - \frac{2.3026 R T}{F} \text{pH}_i + C_i \text{ (internal solution side) } \dots\dots\dots (8.1)$$

$$e_s = - \frac{2.3026 R T}{F} \text{pH}_s + C_s \text{ (sample solution side) } \dots\dots\dots (8.2)$$

- Where: R : gas constant, 8.3145 [J/(mol·K)]  
 T : absolute temperature (t [°C]+273.15) [K]  
 F : Faraday constant, 9.6485×10<sup>4</sup>[C/mol]  
 C<sub>i</sub> : potential at interface between glass and internal solution  
 C<sub>s</sub> : potential at interface between glass and sample solution

Given the potential at internal solution side is reference, the difference across the membrane  $e_g$  is:

$$e_g = e_s - e_i = \frac{2.3026 R T}{F} (\text{pH}_i - \text{pH}_s) + (C_s - C_i) \dots\dots\dots (8.3)$$

To determine the difference of membrane potentials, two inner electrodes are incorporated in a glass electrode and a reference electrode and the difference in potential at two electrodes is measured by a pH converter with high input impedance. This potential difference  $E_g$  is expressed as follows when the difference of single electrode potential of the two inner electrodes and  $C_s - C_i$  in equation 8.3 are collectively represented by  $E_{AS}$ .

$$E_g = \frac{2.3026 R T}{F} (\text{pH}_i - \text{pH}_s) + E_{AS} \dots\dots\dots (8.4)$$

$$E_g = (54.20 + 0.1984 t) \times (\text{pH}_i - \text{pH}_s) + E_{AS} \dots\dots\dots (8.5)$$

In the equation,  $\text{pH}_i$  is the pH buffer solution filled in the glass electrode so the pH should be constant. Using a solution (pH standard solution) with known pH as  $\text{pH}_s$  at a certain temperature, the relationship between millivolt and pH can be determined, thereby the pH can be directly derived from the membrane potential difference, as shown in Figure 8.3.

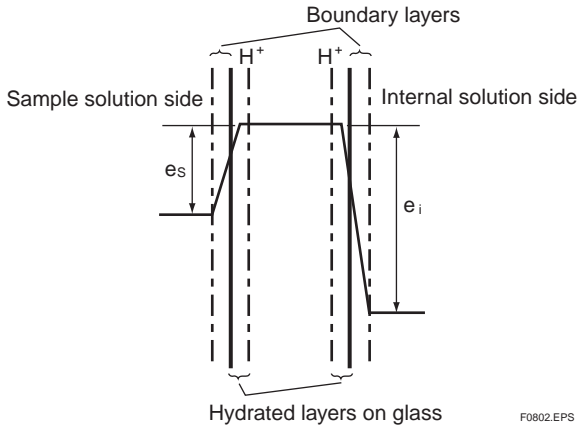

F0802.EPS

**Figure 8.2** Diagram of Glass Membrane

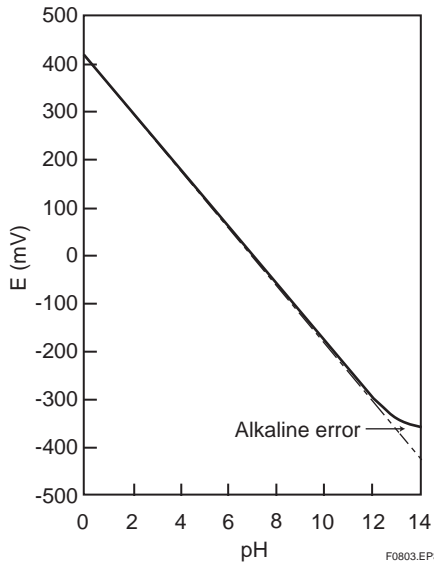

F0803.EPS

**Figure 8.3** Relationship between Glass Electrode Potential and pH

8. Technical Information

### 8.3 Temperature Compensation

In equation 8.3,  $2.3026RT/F$  represents the emf per pH unit and varies depending on temperature.

**Table 8.1 EMF per pH (values of  $2.3026RT/F$ )**

Temperature (°C)	2.3026RT/F (mV)	Temperature (°C)	2.3026RT/F (mV)	Temperature (°C)	2.3026RT/F (mV)
0	54.20	35	61.14	70	68.09
5	55.19	40	62.14	75	69.08
10	56.18	45	63.13	80	70.07
15	57.18	50	64.12	85	71.07
20	58.17	55	65.11	90	72.06
25	59.16	60	66.11	95	73.05
30	60.15	65	67.10	100	74.04

T0801.EPS

Table 8.1 presents the relationship between the temperature and the emf per pH unit, and the relationship between the pH and the emf at each temperature is shown in Figure 8.4. Measurement without temperature compensation will result in measured pH values including errors as shown in Table 8.2.

The PH71 meter automatically modifies the calibration line according to the temperature measured by the temperature element incorporated in an electrode (except needle type and test tube size pH sensors).

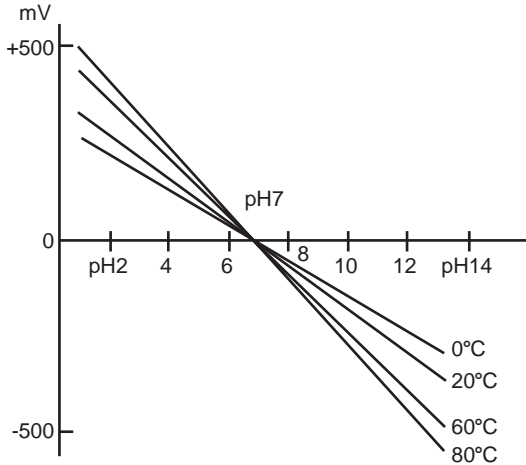

F0804.EPS

**Figure 8.4 pH vs EMF at Each Temperature**

**Table 8.2** Deviations from True Values in Measurement without Temperature Compensation

Temp.(°C) pH	0	20	25	40	60	80
1	0.50	0.10	0.00	-0.30	-0.70	-1.11
3	0.34	0.07	0.00	-0.20	-0.47	-0.74
5	0.17	0.03	0.00	-0.10	-0.23	-0.37
7	0.00	0.00	0.00	0.00	0.00	0.00
9	-0.17	-0.03	0.00	0.10	0.23	0.37
11	-0.34	-0.07	0.00	0.20	0.47	0.74
13	-0.50	-0.10	0.00	0.30	0.70	1.11

T0802.EPS

In addition, the pH value of a solution changes with temperature. The pH value of a solution at the actual temperature may be converted into the one at a reference temperature. This is generally called “conversion to reference temperature,” which is different from the temperature compensation.

## 8.4 The Asymmetry Potential

Theoretically when identical buffer solutions ( $pH_i = pH_s$ ) are present on both sides of the membrane of a glass electrode, the emf should be 0 mV. In reality, some potentials ( $C_s - C_i$ ) develop depending on the thickness of the glass membrane, heat treatment process, service history, or other factors. This is called the real asymmetry potential. In addition to this potential, the difference in single electrode potential between the inner electrodes of the glass electrode and of the reference electrode and a liquid junction potential\* are collectively referred to as the apparent asymmetry potential or just the asymmetry potential. This asymmetry potential is  $E_{AS}$  in equation 8.4.

\* Liquid junction potential occurs due to dirt or clogging of the liquid junction or other factors.

## 8.5 The Alkaline Error

As shown in Figure 8.5, the emf of a glass electrode deviates from the linear value on the alkaline side. This is called the alkaline error. The magnitude of the alkaline error varies depending on the glass membrane compositions. The alkaline error is likely to occur with the presence of sodium and lithium and even with the same pH, it varies depending on the types and concentrations of cations and on the temperature.

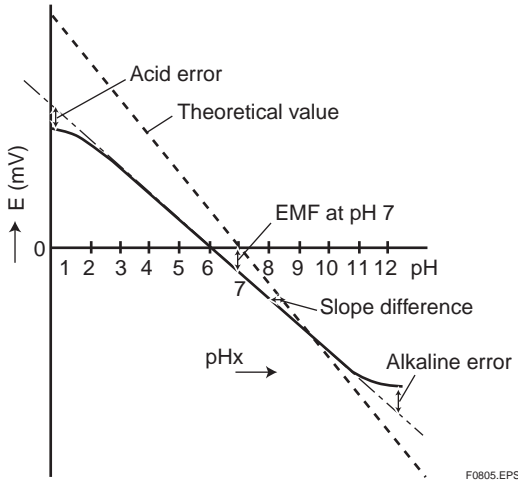

Figure 8.5 EMF Characteristics of Glass Electrode

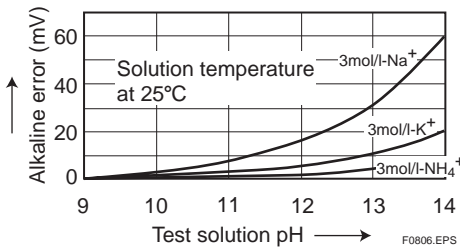
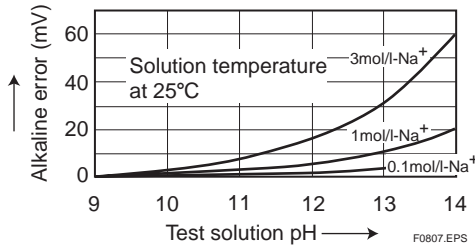

Figure 8.6 Ion Type vs Alkaline Error



**Figure 8.7** Ion Concentration vs Alkaline Error

## 8.6 The Acid Error

The acid error also varies depending on the glass membrane compositions and the types of acids. It increases gradually with immersion time and finally reaches equilibrium. Once a glass electrode has the acid error, it cannot recover soon even by being soaked in a neutral solution and needs considerable time. Practically, the acid error is small compared to the alkaline error so that it is negligible.

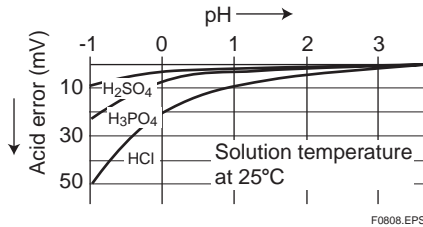
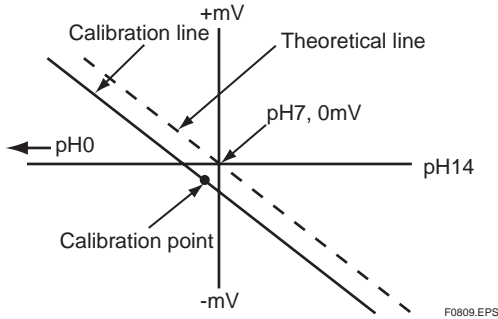

**Figure 8.8** Acid Type vs Acid Error

## 8.7 Calibration Calculation

The PH71 meter is calibrated at 2 points using 2 standard solutions. The first calibration is done so a certain line is drawn through the calibration point (Figure 8.9). The second calibration is done so a line is drawn through the first and second calibration points (Figure 8.10). One-point calibration is a simplified method where only the first calibration of 2-point calibration is performed.

Note: A calibration point is the emf corresponding to the pH value of a standard solution used. (Refer to Table 4.1.)



**Figure 8.9 Calibration at First Point**

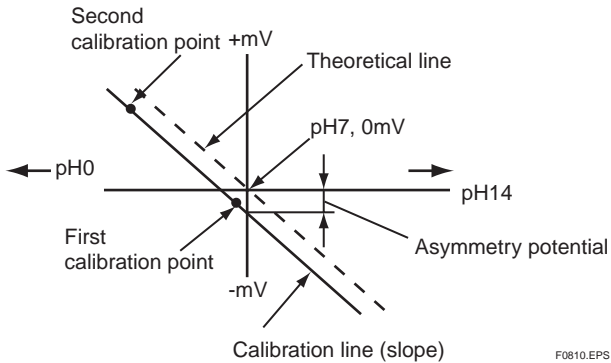

**Figure 8.10 Calibration at Second Point**

## 8.8 Wetted Part Materials of Sensors

- **General pH Sensors**

- Polypropylene resin (sensor body, protective cover)

- Glass (glass electrode, temperature element protective tube)

- Ceramics (liquid junction)

- Silicon rubber (sensor seal)

- When cable is immersed (KCl replenish-free type)

- Rigid polyethylene (sensor grip)

- PVC (sensor cable)

- Ethylene propylene rubber (sensor grip, cable connection)

- **Needle type pH sensor**

- Glass (sensor)

- **Test tube size pH sensor**

- Glass (sensor)

## 8.9 References

- JIS Z8802-1984, *Methods for Determination of pH of Aqueous Solutions*
- Moore, W. J., *Basic Physical Chemistry*, Prentice-Hall, Inc., U.S.A. 1983
- Donald, Andrzej, Julian, *Electrochemistry for chemists 2nd Ed.*, Maruzen 2003
- Bates, R. G., *Determination of pH: theory and practice 2nd Ed.*, John Wiley & Sons, Inc., 1973

## 8. Technical Information



Appendix

● Function Mode

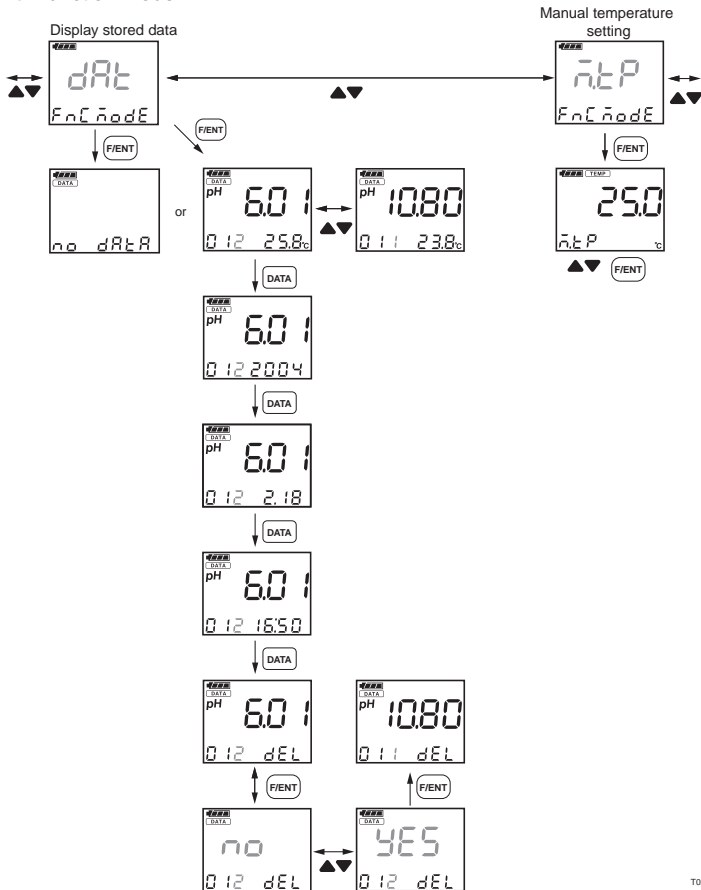

T02.EPS

● Function Mode

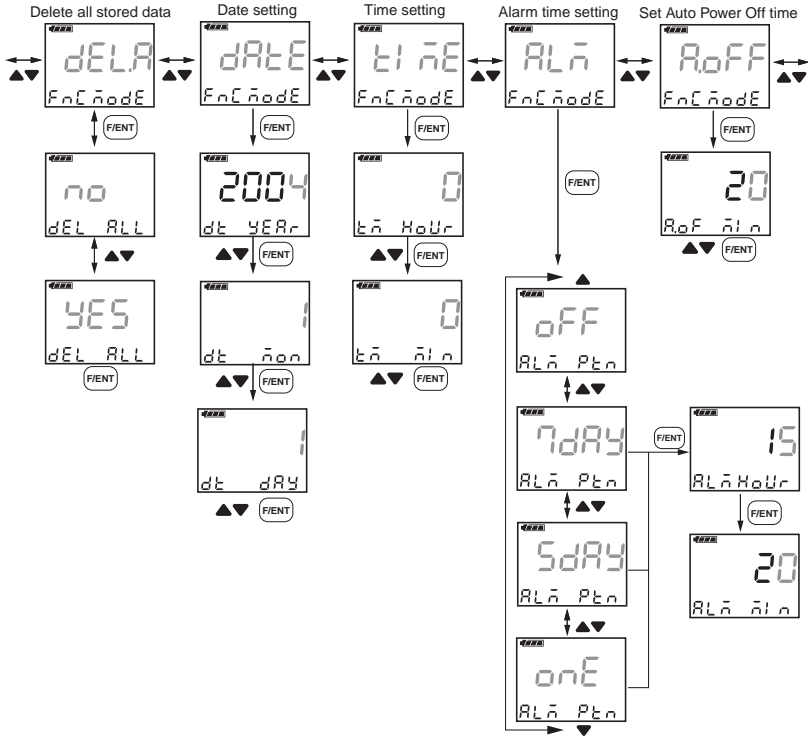

● Switching to Function Mode

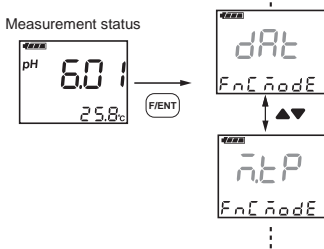

● Reverting to Measurement Mode

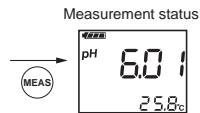

T03.EPS

Appendix

● Function Mode

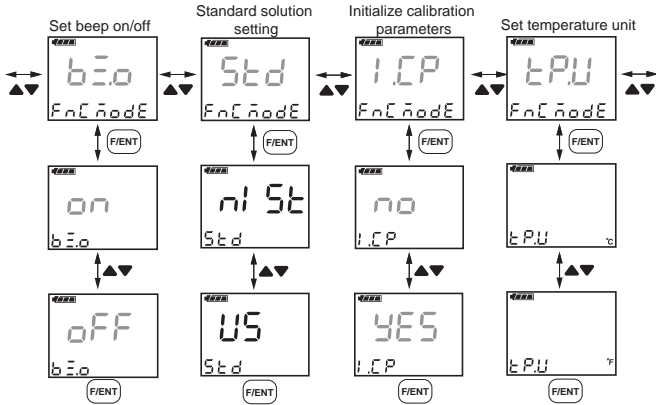

● Function Mode

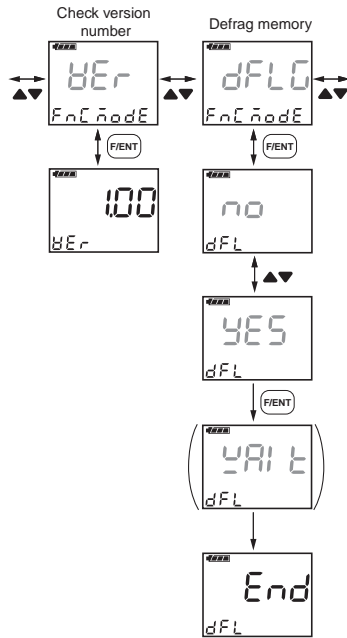

T04.EPS

● Calibration

Automatic calibration & Manual calibration

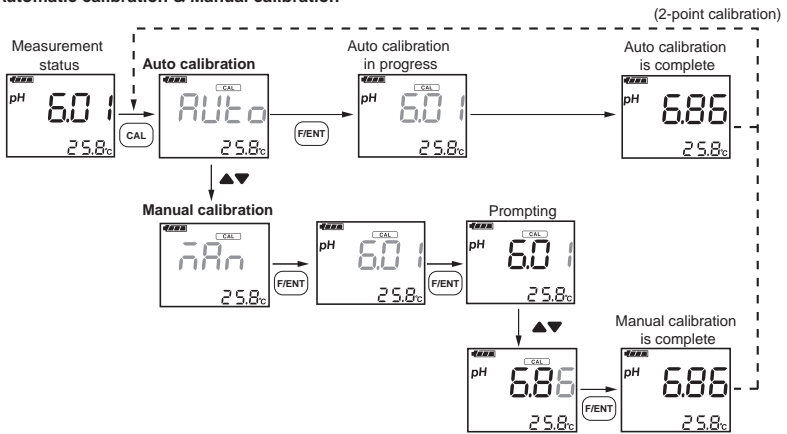

Automatic calibration for needle type or test tube size pH sensor

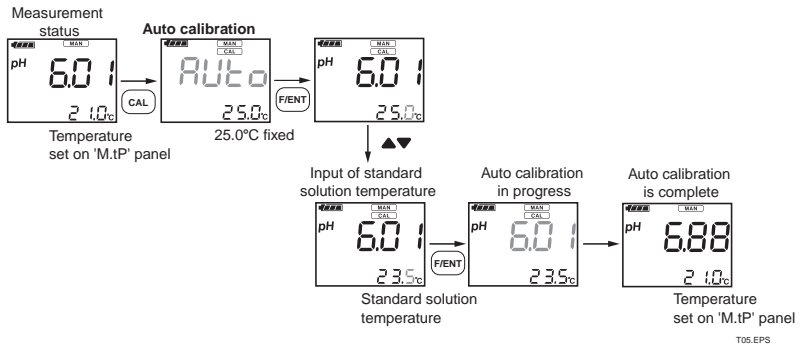

## Appendix

# MSDS (Material Safety Data Sheet)

---

The contents are provided for informative purposes only and no guarantee is given to the accuracy.

The information, such as manufacturers, in the data sheets is subject to change without notice.

	Item	MSDS Product Name	Page
Standard accessories	pH4 standard solution	Phthalate standard solution	MSDS-2 to 4
	pH7 standard solution	Neutral phosphate standard solution	MSDS-5 to 8
	KCl filling solution	Potassium chloride aqueous	MSDS-12 to 15
Options	pH9 standard solution	Borate solution	MSDS-9 to 11

T01.EPS

## Material Safety Data Sheet

**Information on manufacturer**

Company's Name : Toko Chemical Laboratories Co. Ltd.  
Address : Post Code:168-0071  
1-18-8, 1-Chome, Takaido-nishi,  
Suginami-ku, Tokyo, Japan  
Division in charge : Quality Control Division  
TEL : 03-3334-3481 FAX: 03-3334-3484  
Emergency Call : 03-3334-0781 FAX: 03-3334-3484

Reference number A002

January 26, 2004

---

**Product name (chemical name, trade name, etc.)** Phthalate standard solution

---

### Specification of material

Classification of single product and mixture : Mixture  
Chemical name : Acid potassium phthalate solution  
Component and content : Acid potassium phthalate 0.05 mol/l  
Chemical formula or constitutional formula :  $C_6H_4(COOK)(COOH)$   
Reference number of "Notice through official gazettes":  
"Law Concerning Examination and Regulation of  
Manufacture and Handling of Chemical Substances"  
Reg. No. 3-1342  
CAS No. : 877-24-7  
U.N. classification and U.N. No. : Not fall under U.N. standard.

---

### Hazard classification

Name of classification : Not fall under standard of classification.  
Hazardous nature : None  
Harmful effects : May irritate the skin and mucous.  
Environmental impact : Biodegradability is satisfactory.(as phthalic anhydride)

---

### First-aid treatment

Eye contact : Wash with running water for more than 15 minutes.  
Skin contact : Flush with large quantity of water.  
Inhalation : Move that person to a place with clean air and keep him quiet  
in bed. Receive physician's treatment as necessary.  
Ingestion : Immediately rinse out the mouse, and receive physician's  
treatment as necessary.

---

### Measures to be taken in case of fire

Fire-extinguishing method: It is fire-resistant. In case of a fire in the circumference,  
immediately move the container to a safety place.  
Block off the source of combustion to the origin of the fire,  
and extinguish the fire using a fire extinguisher.  
Fire extinguisher : Sprayed water, foam, powder, carbon dioxide

Reference number A002 Phthalate standard solution

---

**Measures to be taken in case of leakage**

When it drops on the floor surface, immediately wipe it to collect in an empty container.  
Flush the remaining solution with water.

---

**Cautions on handling and storage**

Handling : After handling, wash the hand, gargle and wash the face.  
Storage : Avoid direct rays, seal off the container and keep it in a cool place.

---

**Exposure preventions**

Standard control concentration : Not established.  
Acceptable concentration : Japan Society for Occupational Health (1999 edition)  
: Not established.  
ACGIH (1997 edition) : Not established.  
Protection for facilities : Install local ventilation duct, entire ventilation system  
and body washing facilities as necessary.  
Protective equipment : Wear safety goggles, protective gloves, etc. when needed.

---

**Physical/chemical properties**

Appearance : Transparent and colorless liquid      Acidity (pH 4)  
Boiling point : -- °C  
Vapor pressure : -- mmHg ( -- °C)  
Volatility : None  
Melting point : -- °C  
Specific gravity : Approx. 1.0  
Initial boiling point : -- °C  
Solubility : Easy to dissolve into water.  
Others : --

---

**Hazardous property information (stability and reactivity)**

Flash point : No data available  
Ignition point : No data available  
Explosion limit : No data available  
Combustibility : Fire-resistant  
Ignition quality : None  
Oxidizing quality : --  
Auto-reactivity and explosiveness : --  
Stability and reactivity : Stable in ordinary use.

Reference number A002 Phthalate standard solution

---

**Hazardous property information (including human cases and epidemiological information)**

Skin effects : None  
Irritativensess : May irritate the skin and eye.  
Acute toxicity : LD50=7,900mg/kg (oral, rat) (as phthalic acid)  
Ingestion irritates the throat and stomach.  
Subacute toxicity : After a rat was bred for one year with feed containing an additive of phthalic acid of 1 to 4%, no remarkable change was found  
Carcinogenicity : No data available  
Mutagenicity, reproductive toxicity : No data available  
Teratogenicity : After a rabbit was subject to repeated dose on the 7th to 12th day pregnant, no teratogenicity was found.

---

**Ecological information**

Decomposability : Decomposability is satisfactory. (As phthalic anhydride)  
Toxicity to fish : No data available  
Others : (As phthalic acid) Octanol/water distribution coefficient 0.10 to 0.41

---

**Cautions on disposal**

Neutralize with alkali and discharge as pH 5.8 to 8.6.

---

**Cautions on transportation**

Prevent dropping, overturn, collapse of cargo piles, etc. and carefully handle. Do not break or leak the bag.

---

**Applicable law and ordinance**

Labor Security and Hygiene Law, Fire Service Law, Poison Law, PRTR Law  
Dangerous Object Regulation : Not applicable.

---

**Others (cited reference etc.)**

13599 Chemical Goods  
Chemical Daily  
THE MERCKINDEX TENTH EDITION

- 
- \* Since the evaluation of harmful effects and hazardous properties is not always sufficient, be fully careful of handling the material.
  - \* The described contents offer information and do not give any kind of guarantee.
  - \* The above-mentioned cautions are those for ordinary handling. In case of special handling, therefore, take safety measures suitable for intended use.

## Material Safety Data Sheet

**Information on manufacturer**

Company's Name	: Toko Chemical Laboratories Co. Ltd.
Address	: Post Code:168-0071 1-18-8, 1-Chome, Takaido-nishi, Suginami-ku, Tokyo, Japan
Division in charge	: Quality Control Division
TEL	: 03-3334-3481 FAX: 03-3334-3484
Emergency Call	: 03-3334-0781 FAX: 03-3334-3484

**Reference number**    A004 January 26, 2004

**Product name** (chemical name, trade name, etc.)    Neutral phosphate standard solution

### Specification of material

Classification of single product and mixture    : Mixture

**Chemical name**                                         : Potassium dihydrogen phosphate solution  
Disodium hydrogen phosphate solution

**Component and content**                             : Potassium dihydrogen phosphate 0.025mol/l  
Disodium hydrogen phosphate 0.025mol/l

**Chemical formula or constitutional formula**    :  $\text{KH}_2\text{PO}_4$   
 $\text{Na}_2\text{HPO}_4$

**Reference number of "Notice through official gazettes":**  
"Law Concerning Examination and Regulation of  
Manufacture and Handling of Chemical Substances"  
Reg. No. 1-497

**CAS No.**     : 7558-79-4

**U.N. classification and U.N. No.:**                 : --

### Hazard classification

**Name of classification**    : Not fall under standard of classification.

**Hazardous nature**            : None

**Harmful effects**             : Weak toxicity is shown by oral ingestion and  
intravenous administration.

**Environmental impact**    : Discharging a large quantity of the solution in rivers may  
affect them as a rich source of nutrient.

### First-aid treatment

**Eye contact**     : Immediately wash the eye with running water for more  
than 15 minutes, and then wash with boric acid  
solution. Receive eye doctor's treatment.

**Skin contact**    : Flush with water.

**Inhalation**    : Gargle.

**Ingestion**    : When large quantity is ingested, drink water to vomit it, and  
then receive physician's treatment.

### Measures to be taken in case of fire

**Fire-extinguishing method**    : Noncombustible

**Fire extinguisher**                : Water spray

### Measures to be taken in case of leakage

Collect in an empty container and flush the remaining solution with large quantity of water.

Reference number A004 Neutral phosphate standard solution

---

**Cautions on handling and storage**

Handling : Wear protective equipment when needed.  
Storage : Seal off the container.

---

**Exposure preventions**

Standard control concentration : Not established.  
Acceptable concentration : Japan Society for Occupational Health (1999 edition)  
: Not established.  
ACGIH (1997 edition) : Not established.  
Protection for facilities : Install local ventilation duct, entire ventilation system and  
body washing facilities as necessary.  
Protective equipment : Wear safety goggles, protective glove and protective clothing  
when needed.

---

**Physical/chemical properties**

Appearance : Transparent and colorless liquid (Neutral)  
Boiling point : -- °C  
Vapor pressure : -- mmHg ( -- °C)  
Volatility : None  
Melting point : -- °C  
Specific gravity : --  
Initial boiling point : -- °C  
Solubility : 14.8g/100g water, 0°C KH<sub>2</sub>PO<sub>4</sub>  
9.3g/100g water, 20°C Na<sub>2</sub>HPO<sub>4</sub>  
Others : --

---

**Hazardous property information (stability and reactivity)**

Flash point : --  
Ignition point : --  
Explosion limit : Upper limit -- % Lower limit -- %  
Combustibility : None.  
Explosiveness : --  
Stability and reactivity: Stable at normal temperature.

Reference number A004 Neutral phosphate standard solution

**Hazardous property information (including human cases and epidemiological information)**

**Potassium phosphate**

- Skin effects : No data available.  
 Irritativensess : No data available.  
 Acute toxicity : Potassium phosphate differs from sodium phosphate in toxicity to some degree. However, it is considered that there is no difference between them as long as they are used as food additives.  
 MLD >2,000mg(NaH<sub>2</sub>PO<sub>4</sub>)/Kg (Oral Guinea pig)  
 MLD =985 to 1075(NaH<sub>2</sub>PO<sub>4</sub>)/Kg (Vein Rabbit)  
 Subacute toxicity : When the solution is given to a rat as feed additive, high dosage of potassium phosphate or sodium phosphate results in hypertrophied thyroid gland and mineralization of soft tissue.  
 No harmful effect was found in a case where a human took sodium phosphate of 5 to 7g/day for a long period of time.  
 Carcinogenicity : No data available  
 Mutagenicity, reproductive toxicity : No data available  
 Teratogenicity : No data available.

**Disodium phosphate**

- Skin effects : No data available.  
 Irritativensess(skin, eye) : Leaving the solution on the skin may cause itching.  
 The solution irritates the eye temporarily. Leaving this state as it affects the mucous.  
 Acute toxicity : MLD = 985 to 1075mg/kg (Vein Rabbit)  
 LD<sub>50</sub>=12.93g(Na<sub>2</sub> HPO<sub>4</sub> · 7H<sub>2</sub>O)/Kg (Oral Rat)  
 Subacute toxicity : No data available.  
 Carcinogenicity, mutagenicity, reproductive toxicity and teratogenicity: No data available

**Ecological information**

- Decomposability, cumulative effect: No data available.  
 Toxicity to fish : No data available.  
 Others : --

**Cautions on disposal**

- For a small quantity, flush with water.  
 For a large quantity, dispose as waste.  
 When there is a regulation for phosphor, dephosphorizing is required,

**Cautions on transportation**

- Prevent dropping, overturn, collapse of cargo piles, etc. and carefully handle. Do not break or leak the bag.

Reference number A004 Neutral phosphate standard solution

---

**Applicable law and ordinance**

Labor Security and Hygiene Law, Fire Service Law, Poisonous Material Control Law, PRTR Law, Hazardous Materials Shipping and Storage Act  
Dangerous Object Regulation : Not applicable.

---

**Other reference data**

Manual for "Japanese Standards of Food Additives" 7th edition Hirokawa Publishing  
"Pollution, poison and dangerous substance", Author: Hiroshi Horiguchi  
13599 Chemical Goods Chemical Daily

---

- \* Since the evaluation of danger and hazardous properties is not always sufficient, be fully careful of handling the material.
- \* The described contents offer information and do not give any kind of guarantee.
- \* The above-mentioned cautions are those for ordinary handling. In case of special handling, therefore, take safety measures suitable for intended use.

## Material Safety Data Sheet

**Information on manufacturer**

Company's Name : Toko Chemical Laboratories Co. Ltd.  
Address : Post Code:168-0071  
1-18-8, 1-Chome, Takaido-nishi,  
Suginami-ku, Tokyo, Japan  
Division in charge : Quality Control Division  
TEL : 03-3334-3481 FAX: 03-3334-3484  
Emergency Call : 03-3334-0781 FAX: 03-3334-3484

Reference number No A005 Jun 29, 2004

---

Product name (chemical name, trade name, etc.) Borate solution

---

### Specification of material

Classification of single product and mixture : Mixture  
Chemical name : Sodium tetraborate solution  
Component and content : Sodium tetraborate + Hydrate 0.01mol/kg  
Chemical formula or constitutional formula :  $\text{Na}_2\text{B}_4\text{O}_7 \cdot 10\text{H}_2\text{O}$   
Reference number of "Notice through official gazettes":  
"Law Concerning Examination and Regulation of  
Manufacture and Handling of Chemical Substances"  
Reg. No. 1-69  
CAS No. : 1303-96-4  
U.N. classification and U.N. No.: Not fall under U.N. standard.

---

### Hazard classification

Name of classification : Not fall under standard of classification.  
Hazardous nature : Not fall under dangerous substance prescribed by Fire Service  
Law.  
Harmful effects : Ingestion in large quantities is harmful. No corrosiveness.  
Environmental impact : No data available

---

### First-aid treatment

Eye contact : Immediately wash with running water for more than 15 minutes.  
Skin contact : Flush with large quantity of water.  
Inhalation : Move that person to a place with clean air and keep him quiet in  
bed. Gargle with large quantity of water or warm water.  
Receive physician's treatment as necessary.  
Ingestion : Immediately rinse out the mouth, drink large quantity of warm  
water to vomit it and receive physician's treatment.

---

### Measures to be taken in case of fire

Fire-extinguishing method : Noncombustible  
Fire extinguisher : Large quantity of water.

Reference number No A005 Borate solution

---

**Measures to be taken in case of leakage**

When it drops on the floor surface, immediately wipe it to collect in an empty container.  
 Flush the remaining solution with much water.  
 However, as thick waste fluid stains the river, care should be taken so that it may not be discharged.

---

**Cautions on handling and storage**

Handling : Touching with the healthy bare hand causes no injury. However, as the solution is absorbed from the injured skin and defatted skin, avoid handling directly with the bare hand.  
 Storage : Avoid direct rays and humidity, seal off the container and keep it in a cool place.

---

**Exposure preventions**

Standard control concentration : Not established.  
 Acceptable concentration Japan Society for Occupational Health (1999 edition) : Not established.  
 ACGIH (1997 edition) : TLV-TWA 5 mg/m<sup>3</sup>  
 Protection for facilities : Install local ventilation duct, entire ventilation system and body washing facilities as necessary.  
 Protective equipment : Wear dust respirator, safety goggles, protective glove, and protective clothing, when needed.

---

**Physical/chemical properties**

Appearance : Transparent and colorless liquid Alkalinity (pH 9.18)  
 Boiling point : -- °C  
 Vapor pressure : -- mmHg (-- °C)  
 Volatility : None  
 Melting point : -- °C  
 Specific gravity : Approx. 1.0  
 Initial boiling point : -- °C  
 Solubility : Easy to dissolve into water.  
 Others : --

---

**Hazardous property information (stability and reactivity)**

Flash point : No data available  
 Ignition point : No data available  
 Explosion limit : No data available  
 Combustibility : None  
 Ignition quality : None  
 Oxidizing quality : --  
 Auto-reactivity and explosiveness : --  
 Stability and reactivity: Stable in ordinary use.

Reference number No A005 Borate solution

**Hazardous property information (including human cases and epidemiological information)**

Skin effects : None  
 Irritateness : No data available  
 Acute toxicity : LD50 =5.66g/kg (Oral Rat) (As borate)  
 Fatal dose is absorbed from the defatted skin surface or mucous.  
 Taking it orally is hazardous. Absorption by an injection or from the  
 gastrointestinal tract causes vomiting, fever, spasm, mucocutaneous  
 lesion, stomachache, rapid pulse, cyanosis, atrophy, dizziness, etc.  
 (As borate)  
 Subacute toxicity : Using borate-added substance for human consumption for a long  
 period of time may result in xeroderma, anorexia, diarrhea and  
 anemia, sometimes causing liver and kidney damage, coma and  
 fatality.  
 Carcinogenicity, mutagenicity, reproductive toxicity and teratogenicity: No data available

**Ecological information**

Decomposability, toxicity to fish : No data available

**Cautions on disposal**

Neutralize with acid and discharge as pH 5.8 to 8.6.

**Cautions on transportation**

Prevent dropping, overturn, collapse of cargo piles, etc. and carefully handle. Do not break  
 or leak the bag.

**Applicable law and ordinance**

Labor Security and Hygiene Law, Fire Service Law, Poison Law : Not applicable  
 PRTR Law : First grade designated chemical material

**Others (cited reference etc.)**

13599 Chemical Goods Chemical Daily  
 "Pollution, poison and dangerous substance", Author: Hiroshi Horiguchi  
 Sankyo Publishing  
 THE MERCK INDEX TENTH EDITION

- \* Since the evaluation of harmful effects and hazardous properties is not always sufficient,  
 be fully careful of handling the material.
- \* The described contents offer information and do not give any kind of guarantee.
- \* The above-mentioned cautions are those for ordinary handling. In case of special handling,  
 therefore, take safety measures suitable for intended use.

## MATERIAL SAFETY DATA SHEET

Yokogawa Electric Corporation  
2-9-32 Nakacho, Musashino-shi, Tokyo, 180-8750 Japan  
Environment & Analytical Div.  
TEL. 81-422-52-5648  
FAX. 81-422-52-0364

---

PRODUCT                      Potassium Chloride aqueous

---

PRODUCT IDENTIFICATION

Chemical Name : Potassium chloride aqueous  
Composition : 3.3mol/L  
Formula : KCl  
CAS No. : 7447-40-7

---

OTHER INFORMATION : See Potassium chloride MSDS

---

## MATERIAL SAFETY DATA SHEET

page1/3

Revised: Dec-28, 1999 Printed: Dec-28, 1999

MSDS No. K075 (99-476)

NAME: POTASSIUM CHLORIDE

## 1. CHEMICAL PRODUCT IDENTIFICATION AND COMPANY IDENTIFICATION

Product Name : POTASSIUM CHLORIDE

Koso Chemical Co., Ltd. 1-6, Honcho 2-chome, Nihonbashi, Chuo-ku, Tokyo, Japan

Emergency Telephone No. : 048-556-6261

## 2. COMPOSITION/INFORMATION ON INGREDIENTS

Material : Potassium Chloride

CAS No. : 7447-40-7

Formula : KCl

Purity : 99.5 wt%

## 3. HAZARDS IDENTIFICATION

No information.

## 4. FIRST AID MEASURES

In case of contact, immediately flush eyes or skin with copious amounts of water for at least 15 minutes while removing contaminated clothing and shoes.

If inhaled, remove to fresh air.

If swallowed, wash out mouth with water provided person is conscious.

Call a physician. Wash contaminated clothing before reuse.

## 5. FIRE FIGHTING MEASURES

Extinguishing media

Water.

Special firefighting procedures

Incombustibles.

Unusual fire and explosions hazards

No hazards.

## 6. ACCIDENTAL RELEASE MEASURES

To clean the floor and all objects contaminated by this material, collect and after, wash with plenty of water.

Do not breathe dust.

MATERIAL SAFETY DATA SHEET

Revised: Dec-28, 1999 Printed: Dec-28, 1999

MSDS No. K075 (99-476)

NAME: POTASSIUM CHLORIDE

7. HANDLING AND STORAGE

- When using do not eat, drink or smoke.
- Avoid contact with eyes, skin and clothing.
- Wash thoroughly after handling.
- Keep container tightly closed.

8. EXPOSURE CONTROLS/PERSONAL PROTECTION

- Wear suitable protective clothing and gloves.
- Safety shower and eye bath.
- Mechanical exhaust required.

9. PHYSICAL AND CHEMICAL PROPERTIES

- Appearance and odor : White crystals or crystals powder and odorless.
- Melting point : 773 °C
- Specific gravity : 1.98
- Solubility : One gram dissolves in 2.8 ml water, 1.8 ml boiling water, 14ml glycerol, about 250 ml alcohol; insol in ether, acetone.
- pH : about 7.

10. STABILITY AND REACTIVITY

- Stability
  - Stable.
- Incompatibilities
  - No information.
- Hazardous combustion or decomposition products
  - No hazards.
- Hazardous polymerization
  - Will not occur.

11. TOXICOLOGICAL INFORMATION

- Large doses by mouth can cause gastrointestinal irritation, purging, weakness and circulatory disturbances.
- LD<sub>50</sub> = 2,600 mg/kg (orally in rats)

12. ECOLOGICAL INFORMATION

- No information

## MATERIAL SAFETY DATA SHEET

page 3/3

Revised: Dec-28, 1999 Printed: Dec-28, 1999

MSDS No. K075 (99-476)

NAME: POTASSIUM CHLORIDE

## 13. DISPOSAL CONSIDERATIONS

Dissolve in a plenty of water and dispose of this solution.

When using wear suitable protective clothing, gloves and eye/face protection.

## 14. TRANSPORT INFORMATION

No information.

## 15. REGULATORY INFORMATION

TLV and source

No information.

## 16. OTHER INFORMATION

The above information is believed to be correct but does not purport to be all inclusive and shall be used only as a guide.

Responsibility for MSDS : Koso Chemical Co., Ltd.

Address : 1-6, Honcho 2-chome, Nihonbashi, Chuo-ku, Tokyo, Japan

Telephone No. for information : 03-3241-3282

**MSDS**

## Revision Record

---

Manual Title : Model PH71 Personal pH Meter

Manual Number : IM 12B03D01-01E

<b>Edition</b>	<b>Date</b>	<b>Remark (s)</b>
1st	Oct. 2004	Newly published
2nd	Apr. 2008	Addition of information on EMC compliance: P.1-2 Addition of CAUTION: P2-2 Correction: P.1, 1-2, 1-6, 2-1, 2-4, 2-5, 3-1, 5-4, 6-1, 7-6, 8-4, 8-6, 8-7
3rd	Aug. 2009	Change of information on EMC compliance: P.1-2

Thank you for selecting our Model PH71 Personal pH Meter.

There is a part of correction in User's Manual, IM 12B03D01-01E, 3rd Edition, supplied with the product.

Please correct as follows in your copy.

#### Note

- p. 3 Preface, Some revision of "Warranty and Service", addition of "How to replace and dispose the batteries."
- p. 1-7 Some revision of section 1.7 "Options."

## Warranty and Service

Yokogawa products and parts are guaranteed to be free from defects in workmanship and materials under normal use and service for a period of (typically) 12 months from the date of shipment from the manufacturer.

Individual sales units may offer different warranty periods, so the original purchase order should be consulted for the conditions of sale. Damage caused by normal wear and tear, inadequate maintenance, corrosion, or due to chemical processes, is excluded from this warranty coverage. In addition, performance deterioration of the sensor caused by the operating environment mentioned above is not considered to be a defect. Yokogawa cannot carry out repairs in such a case so please replace the sensor.

In the event of a warranty claim, any items that are considered to be defective should be sent (freight paid) for repair or replacement (at Yokogawa discretion) to the service department of the relevant sales unit. The following information must be included in a letter accompanying the returned items:

Model code and serial number

Copy of original purchase order showing the date

Length of time used, and the measuring environment

Fault symptoms, and circumstances of failure

Statement whether service under warranty or out-of-warranty service is requested

Complete shipping and billing instructions for return of goods, plus the name and phone number of a contact person who can be reached for further information

Goods that have been in contact with process fluids must be decontaminated / disinfected before shipment, and a statement to this effect should be included. Safety data sheets for all process components that the goods have exposed to should also be included.

### How to replace and dispose the batteries:

This is an explanation about the new EU Battery Directive (DIRECTIVE 2006/66/EC). This directive is only valid in the EU.

Batteries are included in this product.

When you remove batteries from this product and dispose them, discard them in accordance with domestic law concerning disposal.

Take a right action on waste batteries, because the collection system in the EU on waste batteries are regulated.



Battery type: Alkaline dry cell

Notice:

The symbol (see above), which is marked on the batteries, means they shall be sorted out and collected as ordained in ANNEX II in DIRECTIVE 2006/66/EC.

How to remove batteries safely: Refer to subsection "2.1 Installing the Batteries".

## 1.7 Options (Available Separately)

The following options are available for the Model PH71 Personal pH Meter for your convenience. When ordering, specify the part number.

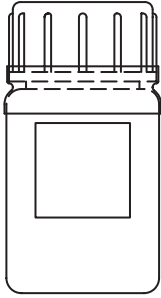
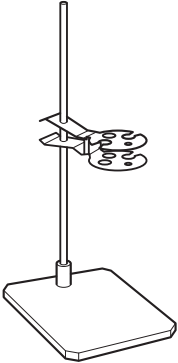
pH 9 Standard solution (Part no. : K9220XF)	Sensor stand (Part no. : K9220XN)
 <p data-bbox="367 746 661 831">Used for calibration when anticipated pH value of sample solution is alkaline. (50ml)</p>	 <p data-bbox="691 746 986 831">Holds a sensor when pH meter is used on the table. Made of rustproof stainless steel.</p>

F010701.EPS